

Linvatec

**LIS8430/LIS8430E
LIS8430W/LIS8430WE
Xenon Light Source
Operating and Service Manual**

Record the Model and Serial No. located on the rear of the light source. Retain this information for future reference.

Model No. _____ Serial No. _____

Important

LIS8430 Xenon Light Source



It is recommended that personnel study this entire Operating and Service Manual before attempting to use, clean, service or adjust the Linvatec LIS8430 Xenon Light Source. The safe and effective use of the equipment is, to a large extent, dependent upon factors under the control of the operator and service personnel, and not entirely controllable by the design of the equipment. It is important that the instructions contained in this manual be understood and followed to enhance safety to the patient and to the operator.

The LIS8430 Xenon Light Source may be configured in the following manner:

- LIS8430/E — This configuration does not come equipped with the COMM/Bit board which allows for communications and internal diagnostics with the LIS8170 Camera.
- LIS8430W/WE — This configuration is equipped with the COMM/Bit board which allows for communications and internal diagnostics with the LIS8170 Camera.

Specifications to "the LIS8430 family of light sources" are inclusive within this documentation unless specifically called out by the following:

LIS8430E — International unit

LIS8430W — Domestic unit with communication capabilities

LIS8430WE — International unit with communication capabilities

This light source complies with IEC 601-1 International Standards as *Type B, Class 1* equipment.

This manual contains information deemed proprietary to Linvatec. The information contained herein, including all designs and related materials, is the property of Linvatec Corporation and/or its licensors. Linvatec and/or its licensors reserve all patent, copyright and other proprietary rights to this document, including all design, manufacturing and reproduction. This document, or any related materials shall not be copied, in whole or in part, without the prior express or written consent of Linvatec.

CERMAX is a registered trademark of ILC Technology Inc.

© Linvatec Corporation 1994. All Rights Reserved. Printed in USA

Service and Warranty

LIS8430 Xenon Light Source

Linvatec's "LIS8430 family of light sources" are designed and manufactured in accordance with sound engineering practices and should provide continuous, reliable and trouble-free service even under the most demanding operating conditions. If this product does not provide satisfactory service, and you are unable to locate the source of trouble, contact your **LINVATEC** Sales Representative or call our Customer Service Department giving all the information available concerning the situation. Do not return the light source without authorization. We may be able to supply you with the information necessary to repair the unit and avoid the transportation problems and costs. If it becomes necessary to return the light source to our factory you must acquire authorization, then pack the unit carefully and return via air freight, prepaid.

The material and workmanship in the "LIS8430 family of light sources" manufactured by/for Linvatec are guaranteed, in materials and workmanship only, for **ONE YEAR** from the date of shipment to the original purchaser. *Light output* is guaranteed to 50% of the rated light output up to a minimum of 500 hours of operation. Any light source or lamp that does not perform to these specifications during this period will be repaired or replaced, at the discretion of Linvatec, without charge, if the cause is the result of material or workmanship that does not perform to stated specifications. Liability under this warranty is limited to the above conditions. Linvatec is not obligated to furnish service for damage resulting from:

- a) attempts by personnel other than Linvatec Representatives to install, repair, or service the product during its warranty period;
- b) improper use, or from connecting the product to incompatible equipment;
- c) modifications to the product by personnel other than Linvatec Representatives.

Linvatec reserves the right to make design changes at any time without incurring any obligation to incorporate these changes to products previously purchased.

This warranty is expressly limited to the terms and conditions as stated above. There are no other implied or expressed warranties or guarantees.

Service and Warranty

**LIS8430 Xenon
Light Source**

Should you have any questions regarding the use or application of the Linvatec LIS8430 Xenon Light Source, or should your light source require servicing or repair, please contact your Linvatec Sales Representative, or contact:

Linvatec

Attn: Customer Service Dept.

11311 Concept Boulevard

Largo, Florida 34643 USA

Phone: 800-237-0169

FAX: 813-399-5256

International Department

Phone: 813-392-6464

FAX: 813-397-4540

Table of Contents

LIS8430 Xenon
Light Source

	Page
Section I	
Introduction	
Description of Instrument	1
Options and Features	1
Description of Manual	1
Receiving Inspection	2
Components	2
Precautions	3
Recommended Good Operating Practices	4
Cleaning	4
Symbol Definitions	5
Controls and Indicators	6
Front Panel	6
Rear Panel	7
Section II	
Operating the Equipment	
Installation	8
Operating Instructions	9
Lamp Module Replacement	10
Section III	
Maintaining the Equipment	
Introduction	12
Reliability and Performance	12
Incoming/Periodic Inspection	12
Mechanical Inspection	13
Lamp Inspection	13
Functional Test	15
Ground Bond Test	18
Leakage Test	18
Lamp Care	18
Lamp Module Replacement	19
Fuse Replacement	20
Calibration	21
Power Supply Checks	21
A6 Optics Alignment	22
A3 Motor Control Calibration (DAC)	23
A3 Video Calibration	23
A1 Lamp Test Calibration	25
Final Check (A4 All Boards)	25
COMM Systems Check	26
Troubleshooting	28
Safety Check-out	41

Table of Contents

LIS8430 Xenon
Light Source

	Page
Section IV	
Theory of Operation & Schematics	
Power Supplies.....	42
Mother/Power Supply Board - A1.....	42
Display Board - A2.....	43
Motor Control Board - A3.....	43
Auto/Manual Button Operation.....	44
Brightness Operation.....	44
Jumper Board - A4 (Standard).....	45
COMM/Bit Board - A4 (optional).....	45
On Board Temperature Sensor.....	46
Status Indicators.....	46
Section V	
Service Information	
Care and Handling of CMOS Logic.....	61
Replacement Parts.....	61
Recommended Spare Parts.....	62
Chassis Parts.....	64
Mother/Power Supply Board Components - A1.....	65
Display Board Components - A2.....	66
Motor Control Board Components - A3.....	67
COMM/Bit Board Components - A4.....	69
Technical Specifications.....	71
Section VI	
Appendix I - Error Messages	
Error Messages.....	72

Table of Contents - Figures

LIS8430 Xenon
Light Source

	Page
Section I	
Figure 1-1 Front Panel	6
Figure 1-2 Rear Panel	7
Section II	
Figure 2-1 Replacing the Lamp Module	11
Section III	
Figure 3-1 Removing the Lamp Module	14
Figure 3-2 Replacing the Lamp Module	20
Figure 3-3 Removal of the Fuse Module	21
Section IV	
Block Diagram	47
Chassis Component Layout Topview	48
System Interconnect A56-152-200 Rev. A	49
Mains Interconnect A56-152-201 Rev. A	50
Mother/Power Supply Board Assembly - A1 A56-152-119 Rev. G	51
Mother/Power Supply Board - A1 Schematic A56-152-209 Rev. B	52
Display Board Assembly - A2 A56-152-008 Rev. C	53
Display Board - A2 Schematic A56-152-208 Rev. C	54
Motor Control Board Assembly - A3 A56-152-010 Rev. K	55

Table of Contents - Figures

Section IV (continued)

	Page
Motor Control Board - A3 Schematic A56-152-210 Rev. D	56
COMM/Bit Board Assembly - A4 A56-152-011 Rev. K	58
COMM/Bit Board - A4 Schematic A56-152-211 Rev. D	58
Jumper Board Assembly - A4 A56-152-099 Rev. A	59
Jumper Board - A4 Schematic A56-152-299 Rev. A	60

Introduction

LIS8430 Xenon Light Source

Description of Instrument

The Linvatec "LIS8430 family of xenon light sources" are designed for easy use, are ideal for exacting surgical procedures that require high intensity daylight color illumination and are durable in typical hospital applications. Applications include orthopaedic, sinoscopy, endoscopy, urology, OB/GYN, plastic/reconstructive, and cardiovascular surgery. All uses of the light source should be carried out according to the instructions in this manual. When the light source is used according to the guidelines provided in this manual, it will provide many years of reliable and satisfactory performance.

The packaging and circuitry of the light source are designed to provide maximum immunity to the electromagnetic interference (EMI) typically found in electrosurgical environments.

Options and Features

The LIS8430 Xenon Light Source is available with an optional COMM/Bit board (LIS8430W/LIS8430WE) which consists of the following features (if used with the LIS8170 Camera consoles):

- initial power-up testing to assure the unit is functioning properly.
- operation diagnostics, while the unit is in use, to check for any malfunctions.
- communications with the LIS8170 Camera console to display diagnostics on the monitor; i.e., light source over temperature or the light intensity is low.
- battery backup to save previous settings in the event of power loss.

Description of Manual

Section I — Introduction, page 1, **Section II — Operating the Equipment**, page 8, and **Section VI — Appendix I - Error Messages**, page 72, have been written for the hospital professional to provide information essential to the correct and safe operation of the "LIS8430 family of light sources".

Section III — Maintaining the Equipment, page 12, **Section IV — Theory of Operation & Schematics**, page 42, and **Section V — Service Information**, page 61, were principally written for the hospital biomedical engineer or technician who will be involved in the routine maintenance and inspection of the unit. Included in these sections are procedures for performing incoming/periodic inspections, technical specifications, circuit descriptions, troubleshooting guide and replacement parts ordering information.

If after reading this manual there are any questions regarding the LIS8430 Xenon Light Source, please call or write Linvatec's Customer Service Department or contact your local Sales Representative.

Introduction

LIS8430 Xenon Light Source

Receiving Inspection

Before shipment, this LIS8430 Xenon Light Source was inspected and found to be free of mechanical and electrical defects. Upon receipt, carefully unpack the unit and examine it for any damage that may have occurred during transit. Save **ALL** packaging materials. They may be needed to verify any claims of damage by the shipper. If signs of damage are observed, immediately file a claim with the transporting agency and notify your Linvatec Representative or Customer Service. Do not attempt to use the light source if any damage has occurred, and do not return the unit until the carrier has inspected it and you have received authorization.

Before installing the light source in the operating room, an Incoming/Periodic Inspection, page 12; Mechanical Inspection, page 13; Lamp Inspection, page 13; Functional Test, page 15; Ground Bond Test and Leakage Test, page 18 should be performed by a qualified technician.

Components

Your LIS8430 Xenon Light Source should contain the following:

- Light Source Console
- Xenon Lamp Module (Cat # 8431 - preinstalled)
- Jumper Board - A4 (standard - preinstalled)
- COMM/Bit Board - A4 (optional)
- BNC Cable - 7.5 Ft.
- Detachable AC Power Cord
- LIS8430/LIS8430W Quick Reference Guide
- LIS8430/LIS8430W Operating and Service Manual

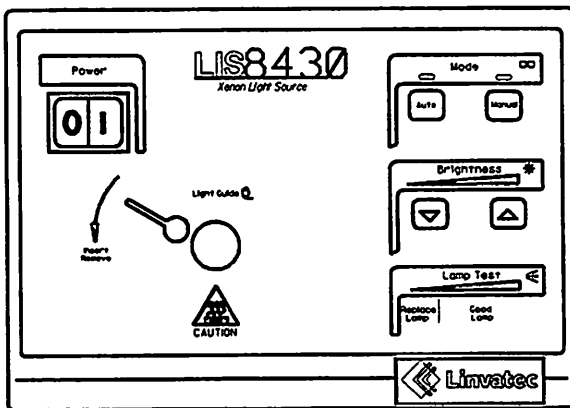

LIS8430 Light Source Console

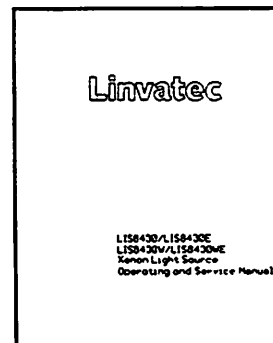

• Operating and Service Manual

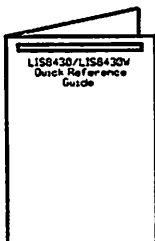

• Quick Reference Guide

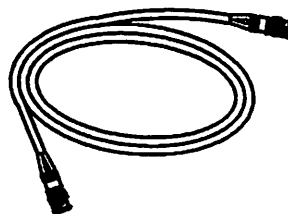

• BNC Cable - 7.5 Ft.

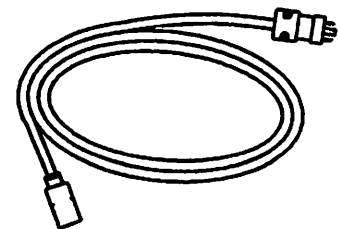

• AC Power Cord

Introduction

LIS8430 Xenon Light Source

Precautions



DANGER



CAUTION



The performance of the light source may degrade if its components are exposed to severe heat. Do not store the light source where it will be exposed to direct sunlight or to temperatures in excess of 104°F (40°C).

Do not use the light source in the presence of flammable anesthetics, gases, disinfecting agents, cleaning solutions, or any material susceptible to ignition due to electrical sparking.

- 1. The LIS8430 Xenon Light Source should be operated by qualified personnel ONLY.**
- 2. To prevent electric shock, do not remove screws or cover. There are no user-serviceable parts inside. Refer servicing to qualified service personnel.**
- 3. Do not expose the light source to rain or moisture, or operate in wet areas. Moisture can damage the light source and also create the danger of electrical shock.**
- 4. Do not touch the light guide receptacle. May cause severe burns.**

The camera cable and light guide should be handled with extra care to avoid unnecessary servicing.

1. Do not stand on the camera cable, light guide or power cords or roll carts or tables over them.
2. Do not pull the video communication cable assembly, light guide or power cable by the cord to remove them from the control unit or a wall outlet.
3. Do not hang, twist, kink or bend the video communication cable assembly, light guide or power cord.
4. Do not block or cover slots and openings in the light source console unit. These openings are provided for ventilation to protect it from overheating.

While the Linvatec LIS8430 Xenon Light Source is designed for use in the operating room, some video accessories may be in use which do not comply with operating room safety regulations. Therefore, routine operating room safety checks should be carried out with the other intended video accessories installed.

Introduction

LIS8430 Xenon
Light Source

Recommended Good Operating Practices



1. Prior to each use, check that all cables are in good working condition — no cracked, split or broken cords.
2. Plug the power cord into a properly grounded outlet.

Grounding reliability can be achieved only when connected to a properly earthed mains supply outlet (Domestic only: receptacle marked "Hospital Only" or "Hospital Grade".) Do not use 2-prong plug adapters or 2-prong extension cords; such devices defeat the safety ground.

3. The light source should be inspected for safe and proper operation by a qualified technician at least every six months.
4. Do not place liquids on or near the light source.
5. At the completion of each use, thoroughly clean the light source console and accessories.

Cleaning

Cleaning of the unit and its accessories should be done after every use. Wipe the unit clean with a soft cloth dampened with a mild detergent (equipment should be turned off and unplugged). Rinse with distilled or sterilized water.

Clean the lens using cotton swabs saturated with 70% alcohol solution to remove spots, residue and streaks. Dry the lenses with a cotton swab or other non-abrasive soft cloth.

Symbol Definitions



Power "OFF", disconnected from the mains.



Power "ON", connected to the mains.



Attention, consult accompanying documents.



Type B equipment.¹



Caution - High Voltage.



Alternating Current.



Protective earth ground.



ISO-Potential Ground



Drip Proof.

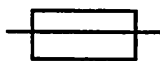

Warning - For continued protection against risk of fire, replace only with the same type and rating fuse.



Caution - HOT

¹ Equipment providing a particular degree of protection against electric shock, particularly regarding:

- allowable Leakage Current
- reliability of the protective earth connection (if present)

Suitable for intentional external and internal application to the patient, excluding DIRECT CARDIAC APPLICATION.

CONTROLS AND INDICATORS

FRONT PANEL

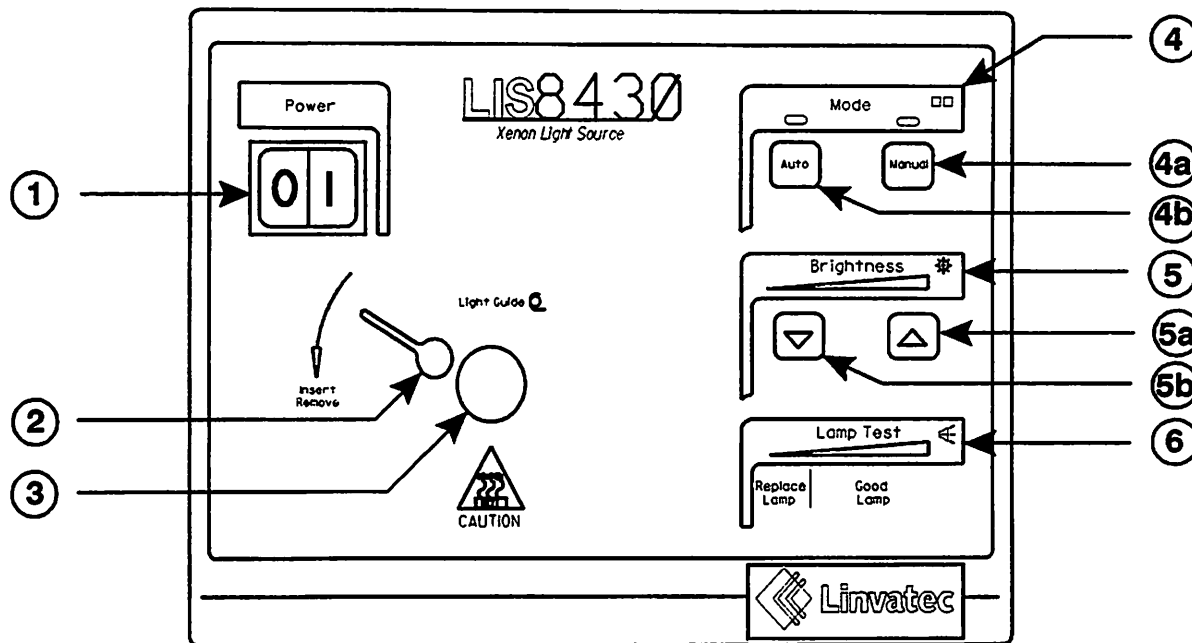

Figure 1-1
Front Panel

1. **Mains Power Switch (I/O)** — Lighted, green rocker-type ON/OFF switch. Used to activate the light source power.
2. **Hand Lever** — Used to open the light guide receptacle for insertion/removal of the light guide.
3. **Light Guide Receptacle** — Light guides are inserted into this receptacle. Will accept various makes of light guides.
4. **Mode Selection** — These buttons are used to set the light source to either the "Auto" mode or the "Manual" mode.
 - 4a. **Manual Button** — The "Manual" LED indicator illuminates when "Manual" is selected. Gives the operator complete control of the lamp intensity, with the Brightness control, from a minimum to a maximum setting.
 - 4b. **Automatic Button** — The "Auto" LED indicator will illuminate when "Auto" is selected. Lamp intensity is automatically controlled through internal circuitry. Intensity may be set by the operator and will be maintained while in "Auto" mode.
5. **Brightness Indicator** — Used to view the level of intensity of the light output while in the "Manual" mode. Also used to preset the intensity level while in the "Auto" mode. Intensity setting is displayed on a LED scale.
 - 5a. **Brightness Increase Button** — Press this button to increase the intensity of the lamp while in the "Manual" mode or to preset the intensity to a higher level in the "Auto" mode.
 - 5b. **Brightness Decrease Button** — Press this button to decrease the intensity of the lamp while in the "Manual" mode or to preset the intensity to a lower level in the "Auto" mode.
6. **Lamp Test Indicator** — A LED indicator that allows the operator to immediately view when the lamp should be replaced, eliminating any guess work.

Introduction

LIS8430 Xenon
Light Source

CONTROLS AND INDICATORS

REAR PANEL

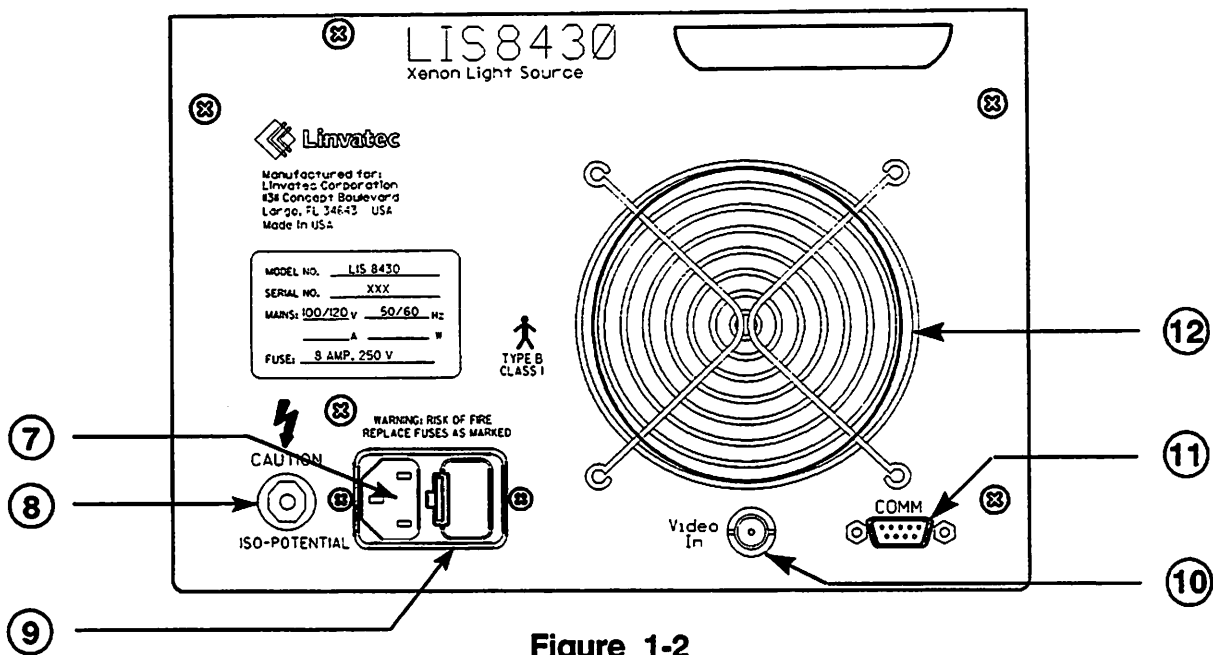



Figure 1-2
Rear Panel

7. **Fuse** — Replace with T8.0 A, 250 V fuse (LIS8430/LIS8430W).

NOTE: The LIS8430E/LIS8430WE Xenon Light Source is equipped with two T4.0 A, 250 V fuses (reference Fuse Replacement on page 20 for instructions on replacing a fuse).

8. **ISO-Potential Ground**  This ground stud is used to bring all individual chassis grounds to a common ground through the use of a simple ISO-connector.

9. **Mains Power Cord Receptacle** — Input power receptacle which allows for readily replaceable power cord with plug.

10. **Video BNC Connector** - This BNC connection is used to connect to any standard video camera.

NOTE: This connection is permanently terminated to 75 ohms. Do not use any "TEE" connector as "Auto" control will be affected.

11. **Communications Channel** - This "COMM" connector is a communications channel between the LIS8430W/LIS8430WE Xenon Light Source and the LIS8170 Camera console. It enables the light source and the camera to talk to each other and display any diagnostic messages on the monitor pertaining to the light source operation (optional COMM/Bit board - A4 must be installed).

12. **Fans** - Removes heat generated by the lamp and lamp power supply.

Operating the Equipment

LIS8430 Xenon
Light Source

Installation

1. Plug the power cord into a properly earthed mains supply outlet 100-120 V~ 60Hz (Domestic only: receptacle marked "Hospital Grade" or "Hospital Use".) (LIS8430E/LIS8430WE - 220-240 V~) as well as the rear of the light source. Before connecting the camera and any accessories to the light source, turn the power ON and assure buttons are functioning properly by pressing them and verifying that the LED's are illuminating. Check the "Lamp Test" indicator  and assure that the lamp indicates "Good Lamp". If after five (5) minutes the "Lamp Test" indicates to "Replace Lamp", turn the power OFF, unplug the unit, and replace the lamp (reference Lamp Module Replacement, page 10). Turn the power OFF and complete the following steps if the light source is functioning properly.

2. If using an LIS8170 Camera console, connect the video communication cable assembly as follows:

- Insert the major cable connector to the "VIDEO ACCESSORIES" receptacle on the back of the camera console.

From the major cable labeled "LIGHT":

- Connect the BNC cable to the Video-In (BNC) connector on the rear of the light source.
- If using the Linvatec LIS8430W/LIS8430WE Xenon Light Source, connect the 9-pin female D-sub connector to the 9-pin male D-sub "COMM" connector on the rear of the light source. Tighten the two (2) screws on the connector to assure a good connection.

3. Before installing a fiber optic light guide into the light guide receptacle on the front panel, check the following items to assure the light guide is in good working condition:



CAUTION

Do not look into the light guide while it is plugged into the light source. Permanent eye injury may result.

- a. Inspect the light guide cables by holding one end to room light and looking at the other end. If more than 30% of the fiber optic cables are darkened, replace the light guide.
- b. Clean the lenses, if dirty, with a 70% alcohol solution and a cotton swab to insure uninhibited light output.



4. Install a dry fiber optic light guide cable by pressing down the hand lever next to the light guide receptacle and inserting the proximal light guide fitting as far as possible. Release the hand lever to firmly retain the light guide tip.
5. Attach the distal end of the light guide to the endoscope using the appropriate adapters.

Operating the Equipment

LIS8430 Xenon
Light Source

Operating Instructions

NOTE

1. Turn on all power switches on the light source, camera console, monitor and any other accessories attached.

If using an LIS8170 Camera console and the LIS8430W/LIS8430WE Xenon Light Source, do not press any function buttons during system diagnostics. Doing so may cause the light source software to lock up. If this occurs, turn the light source OFF and then ON again.

If using an LIS8170 Camera console, a self-test of the system will be initiated upon power-up and will take approximately one (1) minute to complete. During this time a diagnostic message will be displayed on the monitor indicating "DIAGNOSTICS IN PROGRESS". If there is an internal malfunction or if the system is not hooked up completely, the internal diagnostics will display an error message on the monitor screen. (Reference Appendix I - Error Messages, page 72 for a list of error messages and possible actions to take to correct the problem).

When diagnostics are complete, if there are no diagnostic errors, the following message will be displayed through the COMM channel to the monitor (if using the LIS8430W/LIS8430WE Xenon Light source).

CAMERA DIAGNOSTIC OK

LIGHT SOURCE TEST OK

NOTE

When the unit is turned "OFF" (or in the event of a power failure) the internal software will retain the previous settings and will power up to these settings. (Only if using the LIS8430W/LIS8430WE Xenon Light Source).





2. Allow the unit to warm up for approximately five (5) minutes to assure maximum lamp intensity. Check the "Lamp Test" and assure that it indicates the lamp is good. If the "Lamp Test" indicates "Replace Lamp", reference Lamp Module Replacement, page 10, for instructions on how to replace the lamp module.

CAUTION

Avoid placing the light guide's distal end directly on the patient or any flammable materials (e.g., patient drapes, gauze, etc.). The light guide's distal end may transfer extreme heat while in use.





3. To adjust the intensity while in the automatic setting, the light guide and camera must be attached to an arthroscope/endoscope. While viewing an object with the endoscope, adjust the intensity, either up  or down , by pressing the Brightness buttons until the image on the monitor is the desired brightness. The LIS8430 will now automatically maintain this level of brightness.



When set to Auto mode the LIS8430 measures the average video picture brightness and adjusts the lamp output according to the position of the brightness control.

Operating the Equipment

LIS8430 Xenon
Light Source

4. The intensity can be changed and manually controlled by the operator by pressing the "Manual" button on the front panel and then pressing either the decrease  or increase  buttons to control the lamp intensity.

NOTE

The LIS8170 Camera will override the light source Mode select to Manual during power-up. After power-up, the light source Mode select may be changed to the user's preference.

Lamp Module Replacement



CAUTION

1. Turn the power switch (I/O) OFF and allow the lamp module to cool for at least five (5) minutes before handling the lamp module.

Do not handle the lamp module before the unit has had ample time to cool. Severe burn injury may result.

Handle with care! Do not drop the lamp module. The lamp module is assembled under high pressure. Severe injury may result.

2. Remove the LIS8430 Xenon Light Source from the cart to gain access to the lamp module door on the side of the unit.
3. Access to the lamp module is achieved through the door on the left side of the chassis (reference figure 2-1).
4. Slide the door latch to the right to open the door and gain access to the lamp module.
5. Insure the lamp module is cool. Grasp the lamp module bracket and pull straight out. With the bulb facing the front panel, slide the new lamp module in place and close the door. The lamp module will only insert in one direction.

NOTE

Make sure the door is completely closed and latched. There is a disconnect switch located within the door assembly which will not allow the unit to start if it is not closed and latched completely.

Operating the Equipment

LIS8430 Xenon
Light Source

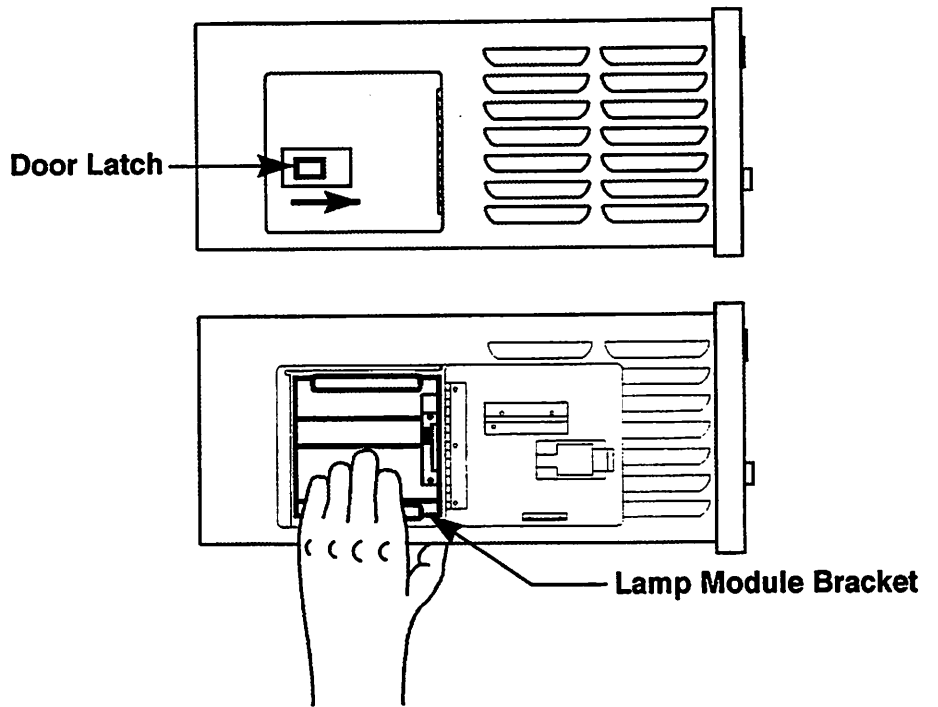

Figure 2-1 Replacing the Lamp Module

Maintaining the Equipment

LIS8430 Xenon
Light Source

Introduction

 **CAUTION**

 **WARNING**

The Maintenance and Service Sections of this manual for the Linvatec LIS8430 Xenon Light Source contain information for service trained personnel to adjust, service, and test the light source.

AC Power Source and Connection. The Linvatec LIS8430 Xenon Light Source operates from a single-phase power source. The voltage to ground (earth) from either pole of the power source must not exceed the maximum rated operating voltage of 130 V~ (LIS8430E/ LIS8430WE - 250V~). Grounding reliability can only be achieved when connected to a properly earthed mains supply outlet (Domestic only: receptacle marked "Hospital Only" or "Hospital Grade".) Do not defeat the grounding connection in any way such as: using 2-prong plug adapters or 2-prong extension cords. Any interruption of the grounding connection can create an electric shock hazard.

Dangerous potentials exist at several points throughout the LIS8430 Xenon Light Source. The cover assembly should only be removed by a qualified technician when calibrating or troubleshooting the unit. Do not touch exposed connections or components as severe electrical shock may occur. Disconnect power from source prior to replacing parts or cleaning the light source.

Reliability and Performance

For continued protection, reliability, and performance, no changes should be made to the original design of this unit. Exact factory replacements are recommended for all parts needing replacement. The use of any unauthorized substitute parts may create an electrical shock, fire or other hazard.

Incoming/Periodic Inspection

Linvatec performs a rigorous checkout and burn-in test at the factory prior to shipment. Our equipment is shipped using custom packing materials; however, it is possible for mechanical failures to occur from shock and vibration during transit. For this reason and to ensure that the unit is completely functional, it is imperative that an incoming inspection be performed.

Carefully unpack the light source; inspect all exterior components and chassis for scratches, dents and other signs of physical damage. If damage exists DO NOT attempt to use the light source. Notify the carrier immediately as well as your Linvatec Sales Representative or Customer Service.

If the equipment appears to be in good mechanical condition, proceed with the following incoming/periodic inspection procedures.

Periodic inspections should be performed at least every six months to ensure safe and proper operation. Calibration should be performed whenever any repairs or adjustments are made.

Maintaining the Equipment

LIS8430 Xenon
Light Source

Mechanical Inspection

Areas to be checked are as follows and must be done in the order listed:

1. Mechanical Inspection
2. Lamp Inspection
3. Functional Test
4. Ground Bond Test
5. Leakage Test
6. Calibration

1. Inspect all exterior components, surfaces and corners for signs of physical abuse. An instrument which has been dropped should be disassembled and checked internally, by a qualified technician, to verify that no components or hardware have been damaged.
2. Inspect the power cable and the video cable; verify that the insulation is intact and that there are no sharp bends or kinks. Damaged cables should be replaced.
3. Check the hand lever to assure that it is working correctly; moves easily with no binding.
4. Check the Video-In and COMM connectors on the rear panel. Assure they are not bent or damaged in any way.
5. Remove the cover by unscrewing the 4 Phillips-head screws located on the bottom of the chassis and the 2 Phillips-head screws located on the rear panel. Open the lamp access door and slide the cover towards the rear of the unit.
6. Inspect the printed circuit cards for discoloration of the glass material which may indicate overheating.
7. Verify that all connectors are securely mated.

This completes the Mechanical Inspection. Replace the cover before going on to the lamp inspection.

Lamp Inspection

1. Remove the lamp module from the light source unit. Access to the lamp module is achieved through the door on the left side of the chassis (figure 3-1).
2. Slide the door latch to the right to open the door and gain access to the lamp module.

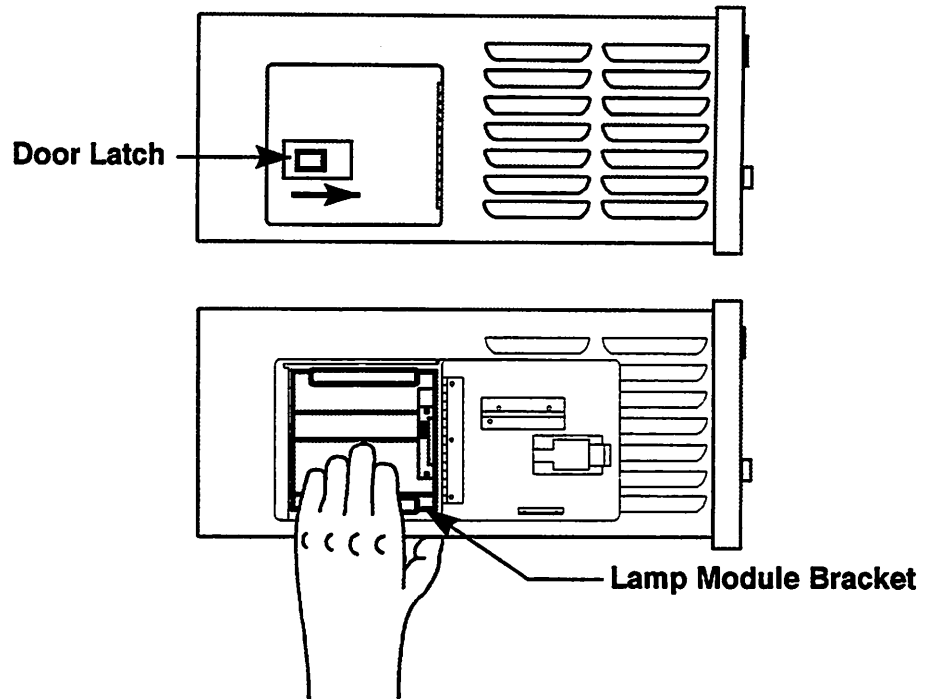

Figure 3-1 Removing the Lamp Module

3. Grasp the lamp module bracket and pull straight out.



CAUTION

Do not drop the lamp module. The lamp module is assembled under high pressure. Severe injury may result.

4. Inspect the lamp module and replace with LIS Cat. No. 8431 if any of the following conditions are observed:
 - a. cracks on the sapphire lens.
 - b. clouding or discoloration of the sapphire lens.
 - c. carbon tracks or indications of aging.
 - d. loose connectors.
 - e. loose or broken heatsink components.
5. With the bulb facing the front panel, slide the new lamp module in place and close the door. The lamp module will only insert in one direction.

Maintaining the Equipment

LIS8430 Xenon
Light Source

NOTE

Ensure that the door is completely closed and latched. There is a disconnect switch located within the door assembly which will not allow the unit to start if it is not closed and latched completely.

This completes the lamp inspection. Continue on to the Functional test.

Functional Test

The purpose of the functional test is to assure that the light system is fully operational.

Equipment required:

- Fiber Optic Light Guide
- BNC Cable
- Video Communication Cable Assembly (if using LIS8170 camera)
- LIS8170 Camera Unit or other camera unit
- Camera Head
- Camera Coupler
- Endoscope
- Monitor
- AC Power Cord

Procedure:

1. Plug the power cord into a properly earthed mains supply outlet 100-120 V~ 60Hz (Domestic only: receptacle marked "Hospital Grade" or "Hospital Use".) (LIS8430E/LIS8430WE - 220-240 V~) as well as the rear of the light source. Before connecting the camera and any accessories to the light source, turn the power ON and assure buttons are functioning properly by pressing them and verifying that the LED's are illuminating. Check the "Lamp Test"  indicator and assure that the lamp indicates "Good Lamp". If, after five (5) minutes, the "Lamp Test" indicates to "Replace Lamp", turn the power OFF, unplug the unit, and replace the lamp (reference Lamp Module Replacement, page 10). Turn the power OFF and complete the following steps.
2. If using an LIS8170 Camera console, connect the video communication cable assembly as follows:
 - Insert the major cable connector to the "VIDEO ACCESSORIES" receptacle on the back of the camera console.

From the major cable labeled "LIGHT":

- Connect the BNC cable to the Video-In (BNC) connector on the rear of the light source.

Maintaining the Equipment

LIS8430 Xenon
Light Source



CAUTION

- If using the Linvatec LIS8430W/LIS8430WE Xenon Light Source, connect the 9 pin female D-sub connector to the 9-pin male D-sub "COMM" connector on the rear of the light source. Tighten the two (2) screws on the connector to assure a good connection.

3. Before installing a fiber optic light guide into the light guide receptacle on the front panel, check the following items to assure light guide is in good working condition:

Do not look into the light guide while it is plugged into the light source. Permanent eye injury may result.

- a. Inspect the light guide cables by holding one end to room light and looking at the other end. If more than 30% of the fiber optic cables are darkened, replace the light guide.
- b. Clean the lenses, if dirty, with a 70% alcohol solution and a cotton swab to insure uninhibited light output.
- c. When operating the hand lever assure it operates smoothly with no binding.



4. Install a dry fiber optic light guide cable by pressing down the hand lever next to the light guide receptacle and inserting the proximal light guide fitting as far as possible. Release the hand lever to firmly retain the light guide tip.
5. Attach the distal end of the light guide to the endoscope using the appropriate adapters.
6. Turn on all power switches on the light source, camera console, monitor and any other accessories attached.

NOTE

If using an LIS8170 Camera console and the LIS8430W/LIS8430WE Xenon Light Source, do not press any of the function buttons during diagnostics. Doing so may cause the light source software to lock up. If this occurs, turn the light source OFF and then ON again.

If using an LIS8170 Camera, a self-test of the system will be initiated upon power-up and will take approximately one (1) minute to complete. During this time a diagnostic message will be displayed on the monitor screen indicating "DIAGNOSTICS IN PROGRESS". If there is an internal malfunction or if the system is not hooked up completely, the internal diagnostics will display an error message on the monitor screen. (Reference Appendix I - Error Messages, page 72 for a list of error messages and possible actions to take to correct the problem).

Maintaining the Equipment

LIS8430 Xenon
Light Source

When diagnostics are complete, if there are no diagnostic errors, the following message will be displayed through the COMM channel to the monitor (if using the LIS8430W/LIS8430WE Xenon Light Source).

CAMERA DIAGNOSTIC OK

LIGHT SOURCE TEST OK

NOTE



When the unit is turned "OFF" (or in the event of a power failure), the internal software will retain the previous settings and will power up to these settings. (Only if using the LIS8430W/LIS8430WE Xenon Light Source).



7. Allow the unit to warm up for approximately five (5) minutes to assure maximum lamp intensity. Check the "Lamp Test" and assure that it indicates the lamp is good. If the "Lamp Test" indicates "Replace Lamp", reference Lamp Module Replacement, page 10, for instructions on how to replace the lamp module.





CAUTION

Avoid placing the light guide's distal end directly on the patient or any flammable materials (e.g., patient drapes, gauze, etc.). The light guide's distal end may transfer extreme heat while in use.



8. To adjust the intensity while in the automatic setting, the light guide and camera must be attached to an arthroscope/endoscope. While viewing an object with the endoscope, adjust the intensity, either up  or down , by pressing the Brightness buttons until the image on the monitor is the desired brightness. The LIS8430 should now automatically maintain this level of brightness.



9. The intensity can be changed and manually controlled at any time by the operator by pressing the "Manual" button on the front panel and then pressing either the decrease  or increase  buttons to control the lamp intensity.

This completes the functional test. Turn the power OFF to all pieces of equipment and disconnect the accessories.

Maintaining the Equipment

LIS8430 Xenon
Light Source

Ground Bond Test

The purpose of this test is to check the continuity of the ground bond from the power plug to the chassis whenever any maintenance has been performed on the unit.

Test Equipment Required:

Simpson Model 265 ohmmeter or equivalent

Procedure:

1. Set the ohmmeter to the lowest ohms range. Connect the test leads to each other and zero the instrument.
2. Connect one test lead to chassis ground. Connect the other test lead to the power cord ground pin. Measure the resistance value. The meter should measure less than 0.1 ohm.
3. If the reading obtained is greater than 0.1 ohm, the line cord or chassis wiring may be damaged. The unit should not be placed into service until the source of the problem is determined and corrected.

Leakage Test

The AC leakage from any exposed metal part to earth ground and from all exposed metal parts having a return to chassis must not exceed $100\mu\text{a}$.

Test Equipment Required:

Bio-Tek Instrument, Model 510 or equivalent

Procedure:

1. Assure the power cord is plugged into the rear of the light source. Plug the light source power cord into the test receptacle of the Bio-Tek instrument, turn the light source ON and press the chassis leakage button.
2. Check the leakage with the line polarity normal and reversed, and with the third wire (earth) grounded and not grounded. The maximum limit is $100\mu\text{a}$.

Lamp Care



1. Lamp output is continuously monitored and should be changed when the "Lamp Test" indicator is illuminated in the "Replace Lamp" area.
2. Lamp life (which is rated for 500 hours) is extended by minimizing the number of starts and stops. Do not turn the unit off if it will be used again in a few minutes.

Maintaining the Equipment

LIS8430 Xenon
Light Source

Lamp Module Replacement



CAUTION

3. Do not touch the lamp bulb or reflector.
4. Do not block the air intakes or exhaust. Keep them free and clear of all obstacles.
1. Turn the power switch (I/O) OFF and allow the lamp to cool for at least five (5) minutes before handling the lamp assembly.

Do not handle the lamp module before the unit has had ample time to cool. Severe burn injury may result.

Handle with care! Do not drop the lamp module. The lamp module is assembled under high pressure. Severe injury may result.

2. Remove the LIS8430 Xenon Light Source from the cart to gain access to the lamp module door on the side of the unit.
3. Access to the lamp module is achieved through the door on the left side of the chassis (reference figure 3-2).
4. Slide the door latch to the right to open the door and gain access to the lamp module.
5. Insure the lamp module is cool. Grasp the lamp module bracket and pull straight out. With the bulb facing the front panel, slide the new lamp module in place and close the door. The lamp module will only insert in one direction.

NOTE

Make sure the door is completely closed and latched. There is a disconnect switch located within the door assembly which will not allow the unit to start if it is not closed and latched completely.

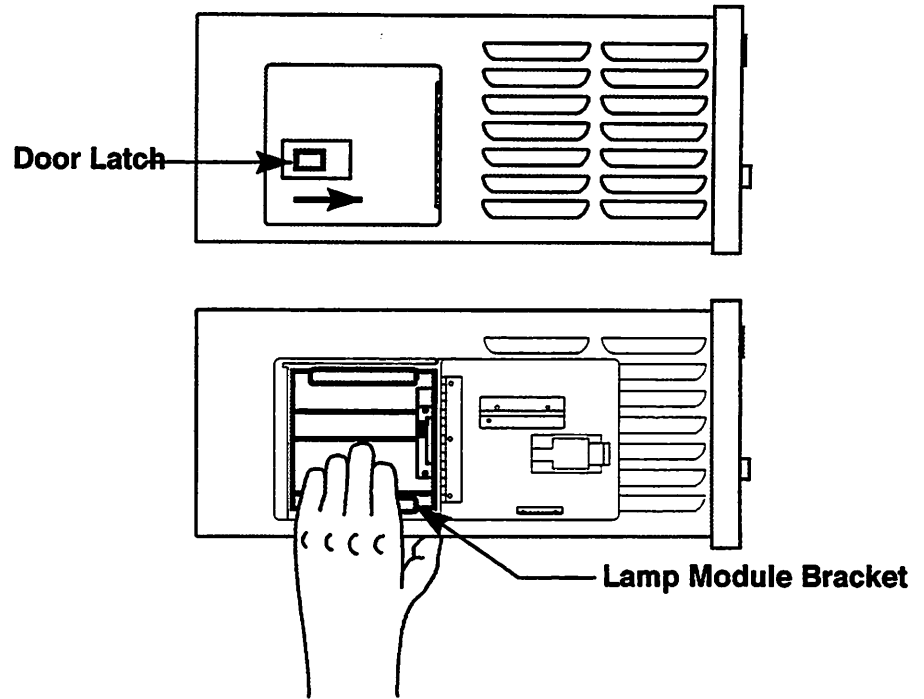

Figure 3-2 Replacing the Lamp Module

Fuse Replacement

In the event of a blown fuse, a new one can be replaced quickly and easily (reference figure 3-3).

1. Turn the power OFF and Insert a small screwdriver or other small instrument into the small rectangular opening of the fuse module.
2. Press the screwdriver blade against the fuse module lever to open.
3. Once the fuse module is removed, the fuse may easily be removed and replaced. Replace only with the designated fuse as stated on the rear panel of the light source or in the Recommended Spare Parts section on page 62 of this manual.
4. Replace the fuse module and press to lock into place.

Maintaining the Equipment

LIS8430 Xenon
Light Source

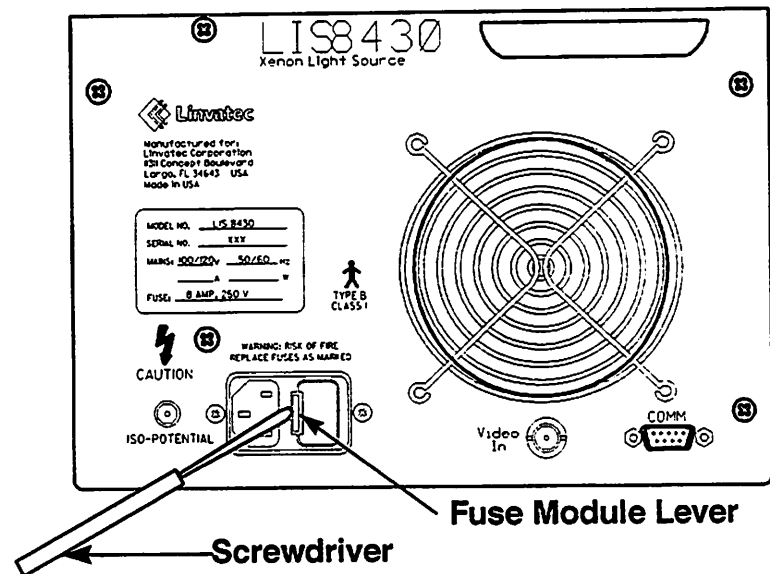

Figure 3-3 Removal of the Fuse Module

Calibration

The LIS8430 Xenon Light Source should be calibrated immediately after any repairs or adjustments are made.

NOTE

Unless otherwise specified, all ground test points will be associated with test points measured i.e. if measuring A3TP5, then use A3TP1 as ground.

Power Supply Checks

Test equipment required:

- Oscilloscope - 100MHz minimum with 10X probe
- DMM/AMM - Fluke 8000A or equivalent
- TV Trigger - Phillips or equivalent (not required if oscilloscope has built in TV triggering)
- Video pattern generator - Leader LCG-396 or equivalent
- Light output meter
- Video camera - LIS8170 or equivalent (8160 may be substituted)
- Rigid scope - Laparoscope, 0° to 30°, eye or cartridge
- Camera to scope coupler - 35mm
- Flexible light guide - LIS7479 or equivalent
- Video monitor - LIS7114 or equivalent
- Interlock switch key
- 8430 extender card (optional)
- 8430 shutter calibration tool

Maintaining the Equipment

LIS8430 Xenon
Light Source

Procedure:

1. Remove the cover by unscrewing the 4 Phillips-head screws located on the bottom of the chassis and the 2 Phillips-head screws located on the rear panel. Open the lamp access door and slide the cover towards the rear of the unit.
2. Insert interlock switch key into door interlock switch located under the lamp module assembly (reference Chassis Component Layout Topview drawing on page 48 for location of interlock).
3. Verify power outlet voltage and frequency to be $\pm 5\%$ of device under test (DUT) ID nameplate requirements.
4. Plug power cord into a properly grounded outlet.
5. Turn the mains power switch ON.
6. Using a DMM measure the following:

A1TP1	+4.7 to +5.3VDC
A1TP2	+14.2 to +15.8VDC
A1TP3	-4.7 to -5.3VDC
A1TP4	-14.2 to -15.8VDC

7. Turn the power switch OFF.

Procedure:

1. Loosen the three (3) Optics support screws.
2. Disconnect A1P9 from the Mother/power supply board (A1). Route harness wires away from the light path. Rotate the shutter to beyond the maximum position.
3. Turn the device under test (DUT) to ON. Allow to warm-up for two (2) minutes minimum.

Shock Hazard! Extremely high voltages inside.

Burn Hazard! Lamp and internal optics components get extremely hot!

Fire hazard! Do not place flammable materials into the light path or directly in front of the light guide receptacle.

Do not look into the light guide receptacle or lamp module when the lamp is on. Permanent eye injury may result.

A6 Optics Alignment



WARNING

Maintaining the Equipment

LIS8430 Xenon
Light Source

NOTE

Minimize lamp starts and stops or reduction of lamp service will result.

4. Align optics for a maximum light output.
5. Tighten optics support screws (3).
6. Reconnect A1P9 to the A1 Mother/power supply board.

A3 Motor Control Calibration (DAC)

Procedure:

1. Turn the unit ON.
2. Set the DUT to Manual mode and adjust the Brightness Decrease for minimum intensity.
3. Using a digital multimeter (DMM) verify/adjust A3R4 (A3TP2 = + 0.53VDC \pm 0.05).
4. Using a light meter adjust A3R6 for minimum light output.
5. Set Brightness to default (MID) intensity:
 - If DUT has a standard A4 Jumper board: press button A4SW1 located on the Jumper board.
 - If DUT is equipped with the optional A4 COMM/Bit board: simultaneously press the Brightness Increase/Decrease buttons.
6. Using a light meter adjust A3R8 for MID light output (50% \pm 10% of maximum light).
7. Adjust Brightness Increase for maximum intensity.
8. Using a DMM, verify (A3TP6 = - 0.5VDC \pm 0.50).
9. Adjust Brightness Decrease button for minimum intensity.
10. Using a DMM, verify (A3TP6 = -4.5VDC \pm 0.50). Record Value.

A3 Video Calibration

Procedure:

1. Connect the video pattern generator to the DUT. Select the video pattern generator for — Raster, White (NTSC Video 100 IRE White).
2. Set the oscilloscope sweep for 5ms/div, DC coupled.

Maintaining the Equipment

LIS8430 Xenon
Light Source

NOTE

Do not use black clamp as reference to adjust Vpeak.

3. Using oscilloscope, verify/adjust A3R11 ($A3TP7 = V_{peak} + 7.0V \pm 0.3$).
4. Select the video pattern generator for — Color Bars, IQW OFF, Chroma OFF, Luminance OFF (NTSC 0 IRE video Black).
5. Using the oscilloscope, verify ($A3TP7 = V_{peak} + 3.3V \pm 0.6$).
6. Set DUT to Auto mode and adjust Brightness Decrease for minimum intensity. Adjust A3R14 to MID position.
7. At 100 IRE and using a light meter, preset A3R31 for minimal light level ($A3TP5 = -9.00VDC \pm 0.5$).

NOTE

This is a preset to obtain A3TP5 value at minimum shutter. Further adjustment to A3R31 will be required.

8. Alternate the video pattern generator between 0 IRE and 100 IRE.
9. While at 0 IRE verify/adjust A3R31 ($A3TP5 = \text{value recorded at step 7 plus (+) } 4.25VDC \pm 0.1$).
10. While at 100 IRE verify/adjust A3R14 ($A3TP5 = \text{value recorded at step 7} \pm 0.1$).

NOTE

Interaction between A3R14 and A3R31 will require repeated adjustments until final values are achieved.

11. Repeat steps 9 and 10 until both values are achieved. Ensure that, while at 100 IRE, the shutter does not rotate beyond back side and allow light leakage to output.
12. Disconnect all test equipment.

A2 "Brightness" Bar-Graph Calibration

Procedure:

1. Set the light source to the Manual Mode by pressing the Manual button.
2. Set the Brightness for a default (MID) intensity.
 - If DUT has a standard A4 Jumper board: press button A4SW1 located on the Jumper board.

Maintaining the Equipment

LIS8430 Xenon
Light Source

A1 Lamp Test Calibration

- If DUT is equipped with the optional A4 COMM/Bit board: simultaneously press the Brightness Increase/Decrease buttons.
3. Connect a DMM to A2TP3.
 4. Using a DMM verify/adjust A2R5 and A2R8 for both 10-LED (MID) illumination in the "Brightness" window and (A3TP6 = value recorded at A3 Motor Control Calibration (DAC) step 10).
 5. Adjust Brightness to just within maximum light output.
 6. Verify "Brightness" window indicates (20 LED-1).

Procedure:

1. Set DUT to the Manual mode and adjust Brightness for maximum intensity.
2. Cover photo-diode A1D1 from ALL light.
3. Adjust A1R6 to mid position.
4. Using a DMM measure (A1U1-1 or A1TP6 = $- 8.1\text{VDC} \pm 0.8$).
5. Adjust A2R11 to the mid position.
6. Verify/adjust A2R14 (A2TP5 = value recorded at step 4 $\pm 0.2\text{VDC}$).
7. Remove the photo diode cover.
8. Verify/adjust A1R6 (A1U1-1 or A1TP6 = $+1.2\text{VDC} \pm 0.2$).
9. Turn the DUT OFF.
10. Disconnect test leads from the DUT.

Operational Check:

1. Connect the camera/scope setup (video-in, light guide) to the DUT.
2. Connect the AC ammeter to the DUT mains.
3. Turn the DUT ON. Allow to warm-up for 2 minutes minimum.

Final Check (A4 All Boards)

Maintaining the Equipment

LIS8430 Xenon
Light Source

NOTE

If using the LIS8170 Camera, ensure the auto shutter is OFF (LED will not be illuminated). Press the Auto Shutter ON/OFF button to turn Auto Shutter OFF.

4. Select the Manual mode and set/adjust Brightness for Default intensity per options listed below:
 - If DUT has a standard A4 Jumper board: press button A4SW1 located on the Jumper board.
 - If DUT is equipped with the optional A4 COMM/Bit board: simultaneously press the Brightness Increase/Decrease buttons.
5. Cup a hand and place a scope just inside to view the inside of the hand. Observe the image on the monitor and focus to approximately 3.0 inches (76mm) distance.
6. Select Auto mode and adjust Brightness Increase/Decrease buttons until the image appears nominal (this should be at approximately 1/3 setting).
7. Move the hand at various speeds and distances to verify tracking of the shutter. There should be no evidence of sustained strobing or oscillations. Tracking to appear consistent in both directions of hand motion to and from laparoscope. Repeat the A3 Motor Control and Video Calibration if DUT does not comply with the requirements listed above.
8. Turn the DUT OFF.

COMM Systems Check

NOTE

If DUT has been ON for greater than two (2) minutes, soft-start capacitor A4C3 may charge up preventing full diagnostics functions. Repeat step 2 to reset diagnostics.

3. Within five (5) seconds of each other turn ON both the camera and the DUT light source. While the DUT is performing internal diagnostics (approximately one (1) minute) A4D2 (green) LED will illuminate and A4D1 (red) LED will flash. Upon completion of diagnostics A4D2 (green) LED will illuminate and A4D1 (red) LED will be OFF. Video output of monitor (connected to camera or test device) will indicate "LIGHT SOURCE TEST OK".

Maintaining the Equipment

LIS8430 Xenon
Light Source

4. Toggle the camera shutter switch. Verify when camera shutter is ON, the light source is toggled to "Manual" mode. Toggle the camera shutter switch to OFF. Verify when camera shutter is OFF, the light source is toggled to "Auto" mode.
5. Turn all equipment OFF and disconnect all test equipment. This completes the calibration procedure.
6. Replace the cover by assuring the lamp access door is open. Slide the cover towards the front of the unit. Insert and tighten the four (4) Phillips-head screws located on the bottom of the chassis and the two (2) Phillips-head screws located on the rear panel.

Maintaining the Equipment

LIS8430 Xenon
Light Source

Troubleshooting

NOTE

Whenever service is performed on a unit, the Ground Bond Test, page 18, should be performed to assure the continuity of the ground bond from the power plug to the chassis as well as the Leakage Test, page 18, to determine the amount of leakage.



CAUTION

Dangerous potentials exist at several places within the light source. The cover should only be removed by a qualified technician when troubleshooting the unit. Do not touch exposed connections or components as severe electrical shock may occur. Disconnect power from supply source prior to replacing parts or cleaning.

SYMPTOM

PROBABLE CAUSE

Unit does not power up when main power switch (I/O) is turned ON.

- A. Ensure power cord is plugged into an active receptacle and also the rear of the light source.
- B. Check continuity of fuse (F1) located in the mains power cord receptacle/fuse connector (J1) on rear panel. Replace blown fuse. (Reference the Fuse Replacement directions on page 20).



NOTE

Replace only with the designated rating of fuse as listed in the Recommended Spare Parts list on page 62.

- C. Check line filter (LF1) located on the rear panel. Measure the voltage across the line and neutral pins of line filter (LF1). Should be 100-120 V~ (LIS8430E/LIS8430WE - 220-240 V~). Unplug unit from receptacle and replace if inoperative.
- D. Check power switch (SW1) located on the front panel. Measure the voltage across the output pins (2 and 5) of power switch SW1. Should be 100-120 V~ (LIS8430E/LIS8430WE - 220-240 V~). Unplug unit from receptacle and replace if inoperative.

Maintaining the Equipment

LIS8430 Xenon
Light Source

Troubleshooting (continued)



CAUTION

SYMPTOM

Power ON switch remains illuminated when switch is in the OFF position.

PROBABLE CAUSE

- A. Power switch (SW1) is shorted. Unplug unit from receptacle and replace switch (SW1).

EXTREMELY HIGH VOLTAGE EXISTS IN THE LAMP POWER SUPPLY (PS1). DO NOT CONNECT ANY TEST MEASUREMENT EQUIPMENT DIRECTLY TO ANY HIGH VOLTAGE OUTPUTS. SEVERE DAMAGE OR SHOCK MAY OCCUR!

Lamp Will Not Start.

- A. Check all symptoms previously described.
- B. The lamp interlock switch (SW3) is not fully engaged. Ensure lamp module (LP1) is fully engaged within lamp housing to completely actuate the lamp interlock switch (SW3).
- C. The lamp access door switch (SW4) is not completely engaged. Assure the lamp module access door on the side of the chassis is completely closed and locked to completely actuate the access door interlock switch (SW4).
- D. Unit overheating. Turn the unit OFF and allow the unit to cool off for approximately ten (10) minutes, if hot, and then turn unit on.
- E. Check continuity of fuse (F1) located in the mains power cord receptacle/ fuse connector (J1) located on the rear panel. Replace fuse if blown. (Reference the Fuse Replacement directions on page 20).



NOTE

Replace only with the designated rating of fuse as listed in the Recommended Spare Parts list on page 62.

- F. Check continuity of fuse (F1) on PS1 xenon lamp power supply PCB. Return unit to Linvatec for service.

Maintaining the Equipment

LIS8430 Xenon
Light Source

Troubleshooting (continued)



NOTE

SYMPTOM

PROBABLE CAUSE

The LIS8430 has a thermal switch that shuts down the power if adequate ventilation is not provided. Check the clearance around the unit and allow to cool down before restarting.

G. Check the lamp assembly thermal switch (SW2). With the power OFF, measure the continuity of the thermal switch. Should measure zero ohms. Replace if at fault.

H. Check the lamp assembly interlock switch (SW3). Measure the voltage across the lamp interlock switch. Should be 100-120 V~ (LIS8430E/LIS8430WE - 220-240 V~). Replace interlock switch if at fault.

I. Check the lamp assembly access door interlock switch (SW4). Measure the voltage between pins 3 and 7, and pins 4 and 8. Should be 100-120 V~ (LIS8430E/LIS8430WE - 220-240 V~). Replace access door interlock switch (SW4) if at fault.

J. Check the lamp module to see if it's still operative. Assure there are no cracks on the lens. (Reference Lamp Module Replacement on page 10 for information on removing the lamp module). Also check the "Lamp Test" indicator  on the front panel. Replace the lamp module with a new module and power the unit up to see if the lamp illuminates.



CAUTION

Do not handle the lamp module before unit has cooled for at least 5 minutes. Severe burn injury may result.

Handle with care! Do not drop the lamp module. The lamp module is assembled under high pressure. Severe injury may result.

Maintaining the Equipment

LIS8430 Xenon
Light Source

Troubleshooting (continued)

NOTE

SYMPTOM

PROBABLE CAUSE

- K. Suspect lamp power supply (PS1).
Return unit to Linvatec for repair.

No user-serviceable parts are associated with the lamp power supply. Warranty will be voided if any attempts to service or modify the lamp power supply are made.

Fan(s) Not Operating.

- A. Check all symptoms previously described.
- B. The LIS8430 has a safety thermal switch (SW2) that shuts down the power if adequate ventilation is not provided. Check the clearance around the unit and remove any obstructions near the ventilation ports. Allow unit to cool down before restarting.
- C. Check fans. Measure voltage across connector on the lamp power supply board (PS1). Should be 12 VDC. Replace fan(s) if at fault. Also check wiring to eliminate the possibility of a broken wire from the lamp power supply to the fan(s).

Low Light Output.

- A. Intensity not set high enough. Adjust the intensity by pressing the Brightness  increase button.



CAUTION



Do not look into the light guide while it is plugged into the light source. Permanent eye injury may result.

- B. Inspect the fiber optic light guide. Assure lenses are clean and not more than 30% of the fiber optic cables are darkened. If they are, replace light guide.

Maintaining the Equipment

LIS8430 Xenon
Light Source

Troubleshooting (continued)

SYMPTOM

PROBABLE CAUSE

- C. Scope lenses are dirty. Clean all lenses thoroughly.
- D. Inspect the light guide receptacle window, clean if dirty.
- E. Lamp module is aged. Check the lamp test indicator on the front panel. Change the lamp module.
- F. Check the lamp module filter glasses for contamination. Clean with alcohol and a cotton swab if necessary.

No response from front panel buttons.

- A. If using an LIS8170 Camera module with self-diagnostics an error message will be displayed; "L. S. Panel Switch Fail". This indicates that a front panel switch is permanently engaged and the software has disabled the front panel switches. Software will retain the previous settings (if using the LIS8430W/ LIS8430WE Xenon Light Source). Replace switch panel (part #A56-152-102).



Manual mode selection not working.

- A. Manual button not working (open). With the power off, press the manual button and check continuity across pins 3 and 6 of connector J8 on the mother/power supply board (A1). Press the manual button again and measure continuity. If the switch is open, the ohm meter will show infinite resistance both times which requires replacement of the front switch panel. If both of the measurements show zero resistance, then the switch is fine.

Maintaining the Equipment

LIS8430 Xenon
Light Source

Troubleshooting (continued)

SYMPTOM

PROBABLE CAUSE



Auto mode selection
not working.

- B. Auto button shorted. All front panel buttons will be disabled thru the internal software. If using an LIS8170 Camera console with self-diagnostics, the following error message will be displayed; "L. S. Panel Switch Fail". With the power off, check the continuity across the Auto button. If the switch is shorted, the ohm meter will indicate zero ohms. Replace the switch panel (part # A56-152-102).
- C. Check circuitry on the COMM/Bit PCB - A4. Replace components at fault.

- A. Auto button not working (open). With the power off, press the auto button and check continuity across pins 4 and 6 of connector J8 on the mother/power supply board (A1). Press the auto button again and measure continuity. If the switch is open, the ohm meter will show infinite resistance both times and needs replaced. If both of the measurements show zero resistance, then the switch is fine.
- B. Manual button shorted. All front panel buttons will be disabled thru the internal software. If using an LIS8170 Camera console with self-diagnostics, the following error message will be displayed; "L. S. Panel Switch Fail". With the power off, check for continuity across the manual button. If the switch is shorted, the ohm meter will indicate zero ohms with both measurements. Replace the switch panel (part # A56-152-102).

Maintaining the Equipment

LIS8430 Xenon
Light Source

Troubleshooting (continued)

	SYMPTOM	PROBABLE CAUSE
		C. Check circuitry on the COMM/Bit PCB - A4. Replace components at fault.
■ □	Manual LED not illuminating, but manual operation is working	<p>A. J-K flip-flop (U3) on motor control board (A3) is not operating properly. Check the output signals of J-K flip-flop (U3). The Q output, pin 5, should be hi and the NOT Q output, pin 6, should be lo. Replace J-K flip-flop (U3) if at fault.</p> <p>B. Analog switch (U13) on the motor control board (A3) is not operating properly. Check the voltage between pins 7 and 8 of analog switch U13. Should be +15VDC. Replace switch (U13) if at fault.</p> <p>C. Manual LED (DS2) on the display board (A2) is faulty. Check voltage across manual LED. Replace LED if at fault.</p>
■ □	Auto LED not illuminating, but auto operation is working.	<p>A. Check output signals of IC's U1 and U2 on the motor control board (A3). The output of U1, pin 2 should be lo, pin 4 should be hi, and pin 6 should be hi. The output of U2, pin 8 should be lo. If signals are not present or are not correct, check the supply voltages to IC's, resistors, diode (D1) and capacitors within this circuitry.</p> <p>B. The J-K flip-flop (U3) on the motor control board (A3) is not operating properly. Check the output signal of J-K flip-flop U3. The Q output, pin 5, should be lo and the NOT Q output, pin 6, should be hi. Replace J-K flip-flop U3 if at fault.</p>

Maintaining the Equipment

LIS8430 Xenon
Light Source

Troubleshooting (continued)

SYMPTOM

PROBABLE CAUSE



Brightness increase/decrease are not functioning properly or not at all in manual mode.

- C. Analog switch U13 on the motor control board (A3) is not operating properly. Measure the voltage between pins 9 and 10 of analog switch U13. Should be +15VDC. Replace switch (U13) if at fault.
- D. Auto LED (DS1) on the display board (A2) is faulty. Measure the voltage across the auto LED. Replace LED if at fault.

- A. The up/down counters (U8 and U9) or associated circuitry on the motor control board (A3) are not functioning properly. Measure the input and output signals and voltages. Replace components at fault.
- B. Comparators U15 and/or U14 on the motor control board (A3) are not functioning properly. Measure the input and output signals and voltages. Replace components that are at fault.
- C. Amplifier circuitry not operating properly. Measure the appropriate signals and voltages of transistors Q1 and Q2, diodes D4 and D5, and associated circuitry on motor control board (A3). Replace components that are at fault.
- D. Servo motor used for positioning shutter not operating properly. Measure the appropriate voltages. Replace if at fault.

Maintaining the Equipment

LIS8430 Xenon
Light Source

Troubleshooting (continued)

SYMPTOM

PROBABLE CAUSE



Brightness increase/decrease are not functioning properly or not at all in auto mode.

E. Increase/decrease buttons are either shorted or open. If shorted, all the front panel buttons will be disabled thru the internal software. If using an LIS8170 Camera console with self-diagnostics, the following error message will be displayed; "L. S. Panel Switch Fail". With the power off, check the continuity of both buttons. Replace switch panel (part # A56-152-102).

- A. BNC cable from the video camera to the video-in connector on the rear panel is broken. Replace BNC cable.
- B. The up/down counters (U8 and U9) or associated circuitry on the motor control board (A3) are not functioning properly. Measure the input and output signals and voltages. Replace components that are at fault.
- C. Video section on the motor control board (A3) not functioning properly. Measure the appropriate signals and voltages up to analog switch U4. Replace components that are at fault.
- D. The Q output signal of J-K flip-flop U3 on the motor control board (A3) is not lo. This is used to pull analog switch U13A closed. Check output signals of IC's U1 and U2. The output of U1, pin 2 should be lo, pin 4 should be hi, and pin 6 should be hi. The output of U2, pin 8 should be lo. If these signals are not present or are not correct, measure the supply voltages and signals to IC's, resistors, diode D1, and capacitors within this circuitry.

Maintaining the Equipment

LIS8430 Xenon
Light Source

Troubleshooting (continued)

SYMPTOM

PROBABLE CAUSE

- E. J-K flip-flop U3 is not operating properly. Check the output signal of J-K flip-flop U3. The Q output, pin 5, should be lo and the NOT Q output, pin 6, should be hi. Replace J-K flip-flop U3 if at fault.
- F. Analog switches U13A, U13B and U4C on motor control board (A3) not functioning properly. Measure the voltage between pins 1 and 2 and 15 and 16 of analog switch U13 and pins 9 and 10 of switch U4C. Should be +15VDC. Replace switch(es) (U13/U4) if at fault.
- G. Comparators U15 and/or U14 on the motor control board (A3) are not functioning properly. Measure the input and output signals and voltages of these two comparators. Replace components at fault.
- H. Amplifier circuitry on the motor control board (A3) not operating properly. Measure the appropriate signals and voltages of transistors Q1 and Q2, diodes D4 and D5, and associated circuitry. Replace components that are at fault.
- I. Shutter positioning potentiometer is not functioning properly. Measure for appropriate voltage. Replace if at fault.
- J. Servo motor used for positioning shutter not operating properly. Measure the appropriate voltages. Replace if at fault.

Maintaining the Equipment

LIS8430 Xenon
Light Source

Troubleshooting (continued)

SYMPTOM

PROBABLE CAUSE

- K. Increase/decrease buttons are either shorted or open. If shorted, all the front panel buttons will be disabled thru the internal software. If using an LIS8170 Camera console with self-diagnostics, the following error message will be displayed; "L. S Panel Switch Fail". With the power off, check for continuity of both buttons. Replace switch panel (part # A56-152-102).



Brightness LEDs not functioning.

- A. Shutter positioning potentiometer is not functioning properly. Measure for appropriate voltages. Replace if at fault.
- B. The LED drivers U1 and/or U2 on display board (A2) are not functioning properly. Measure the appropriate input and output voltages and signals. Replace if at fault.
- C. The LED bar(s) on display board (A2) are not functioning properly. Measure voltage. Should be +15VDC. Replace if at fault.

Shutter moving in large increments in the auto mode.

- A. Servo motor is not functioning properly. Measure the voltage at the servo motor. Replace if at fault.
- B. Analog switch U13B on the motor control board (A3) not functioning properly. Measure the voltage across pins 14 and 15 of analog switch (U13). Should be < 1.0VDC. Replace if at fault.

Maintaining the Equipment

LIS8430 Xenon
Light Source

Troubleshooting (continued)

SYMPTOM

PROBABLE CAUSE

- C. The Q output signal of J-K flip-flop U3 is not lo. This is used to pull analog switch U13B closed. Check output signals of IC's U1 and U2. The output of U1, pin 2 should be lo, pin 4 should be hi, and pin 6 should be hi. The output of U2, pin 8 should be lo. If these signals are not present or are not correct, measure the supply voltages and signals to IC's, resistors, diode D1, and capacitors within this circuitry. Replace the circuitry that is at fault.
- D. J-K flip-flop U3 on motor control board (A3) is not operating properly. Check the output signal of J-K flip-flop U3. The Q output, pin 5, should be lo and the NOT Q output, pin 6, should be hi. Replace J-K flip-flop U3 if at fault.
- E. Resistors R23 and/or R24 on the motor control board (A3) are open. Replace if at fault.

No shutter control; no indicators; no button response.

- A. Blown fuse (F1) on mother/power supply board (A1). Check continuity of fuse (F1). Replace if at fault.



NOTE

Replace only with the designated rating of fuse as listed in the Recommended Spare Parts list on page 62.

- B. Check transformer T1 on the mother /power supply board (A1). Check the output of the transformer for a possible short or open. Replace if at fault.

Maintaining the Equipment

LIS8430 Xenon
Light Source

Troubleshooting (continued)

SYMPTOM

PROBABLE CAUSE



Lamp test shows "Replace Lamp", but lamp is still good.

C. Voltage regulators U2-U5 on the mother/power supply board (A1) are not functioning properly. Measure voltages from pin 3 to ground of individual regulators. Should be +5VDC, +15VDC, -5VDC and -15VDC respectively. Replace regulator(s) at fault.

A. Using a new lamp module (catalog #8431) check photo diode D1 on the mother/power supply board (A1). If diode is bad, it will indicate that the voltage is below the preset value and the lamp test LEDs will indicate that the lamp module needs replaced.

B. Check circuitry associated with diode D1 on the mother/power supply board (A1). Potentiometer A1R6 may need adjustment which is used to preset the voltage range for the photo diode. (Reference the calibration procedure on page 21).

C. LED drivers U3 and U4 on the display board (A2) are not functioning properly. Measure appropriate input and output voltages and signals. Replace if at fault.

D. The LED bar(s) (DS5 and DS6) are not functioning properly. Replace if at fault.

NOTE

When using with an LIS8170 Camera console and an error message is displayed on the monitor, reference Appendix I - Error Messages on page 72 for an explanation of the message and a possible solution.

Maintaining the Equipment

LIS8430 Xenon
Light Source

Safety Check-out

After correcting the original service problem(s), perform the following safety checks before releasing the unit for use.

1. Check the area(s) of repair for unsoldered or poorly soldered connections. Check the entire board surface for solder splashes and bridges.
2. Check the interboard wiring to ensure that no wires are pinched, contact high-wattage resistors or have melted insulation.
3. Check that all control knobs, shields, covers, ground straps, and mounting hardware have been replaced. Assure also that all insulators have been replaced.
4. Look for parts which, though functioning, show obvious signs of degradation. Replace them.
5. Check the power cord for cracks and abrasions.
6. Perform the Ground Bond Test, page 18 and the Leakage Test, page 18 after any repairs or calibration have been performed.

The LIS8430 Xenon Light Source consists of 5 sections:

1. Power Supplies
2. Mother/Power Supply Board - A1
3. Display Board - A2
4. Motor Control Board - A3
5. Jumper Board - A4 (standard)
5. COMM/Bit Board - A4 (optional)

Power Supplies

The power supply section furnishes four regulated DC voltages: +5 VDC, -5 VDC, +15 VDC and -15 VDC for internal circuit requirements.

The LIS8430/LIS8430W Xenon Light Source is factory wired for a nominal voltage of 100-120 V~, (Model LIS8430E/LIS8430WE - 220-240 V~) 50/60 Hz operation. Mains transformer (T1) has a multiple tapped primary for 100-120-volt or 220-240-volt operation.

The mains power is supplied to transformer (T1) (which is located on mother/power supply board - A1) via mains fuse/receptacle (J1), line filter (LF1), access door switch (SW4), lamp interlock switch (SW3), thermal switch (SW2), and mains power switch (SW1). At this point the mains power is routed to both the Cermax® lamp power supply (PS1) and the mother/power supply board (A1). On the mother/power supply board (A1), connections are made thru pins 1 and 11 of connector J3 for 100-120 V~ operation (pins 1 and 11 of connector (J2) for 220-240 V~ operation - LIS8430E/LIS8430WE). A line fuse (F1) is also implemented on the mother/power supply board (A1) for further protection.

The lamp power supply (PS1) is a high voltage supply designed specifically to power the Xenon Cermax®, 300W lamp module (LP1).

Mother/Power Supply Board - A1

The mother/power supply board (A1) contains several connectors that accept mating connectors from the daughter boards. Any of the three daughter boards are completely removable, simply by unplugging the connectors, for easy access and maintenance.

The mother/power supply board's (A1) transformer (T1) secondary supplies 17 VAC to the bridge rectifier (BR1). The bridge rectifier's (BR1) output voltage is tapped for both a positive and negative voltage. The positive rectified voltage is sent to fixed voltage regulators U2 and U3, regulated and then filtered for outputs of +5 VDC and +15 VDC respectively. Likewise, the negative rectified voltage is sent to fixed voltage regulators U4 and U5, regulated and then filtered for outputs of -5 VDC and -15 VDC respectively. These voltages are then distributed throughout the internal circuitry.

Display Board - A2

The lamp test display signal originates on the mother/power supply board (A1). Photo diode D1 senses the amount of light being emitted from the lamp module and is compared to a preset reference voltage from R6 thru comparator U1A. This voltage is sent to the lamp test LED drivers U3 and U4 on the display board (A2) and compared internally with a reference adjust voltage. This illuminates the corresponding LED's on the LED bars. As long as the generated light output is at the upper limit the lamp test LED shows "Good Lamp". If the generated light output falls below the preset level, then the "Lamp Test" LED's are not driven as hard and, in turn, shows that the lamp needs to be replaced.

The display board (A2) houses and drives the front panel Auto and Manual button indicators (DS1 and DS2 respectively), the Brightness indicator scale (DS3 and DS4), and the Lamp Test indicator scale (DS5 and DS6).

The display board contains the LED bars (DS3 thru DS6) which are used for the Brightness and Lamp Test indicators. These LED's are driven by LED drivers U1 thru U4 respectively. The settings of the LED indicators are controlled by the outputs from the COMM/Bit board (A4) and the motor control board (A3).

The Brightness display receives an input signal from the shutter positioning potentiometer. This signal is applied to the LED drivers and internally compared with a reference adjust voltage. This, in turn, illuminates the corresponding LED's on the LED bars.

The Lamp Test display signal originates on the mother/power supply board (A1). Photo diode D1 senses the amount of light being emitted from the lamp module and is compared to a preset reference voltage from R6 thru comparator U1A. This voltage is sent to the Lamp Test LED drivers U3 and U4 on the display board (A2) and compared internally with a reference adjust voltage. This illuminates the corresponding LED's on the LED bars. As long as the generated light output is at the upper limit, the Lamp Test LED shows "Good Lamp". If the generated light output falls below the preset level, then the Lamp Test LED's are not driven as hard and, in turn, shows that the lamp needs to be replaced.

Motor Control Board - A3

The motor control board (A3) is an analog circuitry board. Its functions include the control of the Auto and Manual LED's, interpreting the inputs of the increase and decrease buttons for the Brightness control and setting the LED's to the correct brightness positions, and to drive the servo motor for precise shutter control.

Auto/Manual Button Operation



The Auto and Manual LED inputs are derived on this board. When power is applied, the unit comes up in the Auto mode. The Auto and Manual buttons are tied to pull up resistors which set them to a hi setting. The input to U1A is lo on initial power up as well as the input on pin 11 to nand gate U2C. The input to U1A is converted to a hi at its output and converted back to low at the output of U1B. The inputs to nand gate U2C are not all equal (pin 11-lo, pin 10-lo, and pin 9-hi) which gives a hi output. This output is converted thru U1C to a lo which then sets the clear input (pin 15) of J-K flip-flop U3A to a lo state. Meanwhile, with the manual button always set hi, this sets preset (pin 4) of the J-K flip-flop to a hi state. The output of the J-K flip-flop is set to a lo on Q and a hi on Not Q. This pulls switch U13C closed which in turn illuminates the Auto LED (DS1 located on the display board - A2).

After a predetermined amount of time as capacitors C1 and C3 charge, the outputs of U1A and U1B are inverted which puts three hi's at the input of nand gate U2C. The output of nand gate U2C is lo and then inverted thru U1C to a hi which is sent to the clear input (pin 15) of J-K flip-flop U3A. The preset input (pin 4) of U3 is still set to a hi state and the outputs of the J-K flip-flop remain unchanged.

When the Manual button is pushed on the front panel, the following events take place: The active states remain unchanged thru inverter U1C. The signal from the manual button applies a lo to the preset input (pin 4) of J-K flip-flop U3A. This resets the output of the flip-flop to a state of Q-hi, Not Q-lo. This, in turn, opens switch U13C (the Auto LED - DS1) and closes switch U13D (the Manual LED - DS2 located on the display board - A2).

Brightness Operation



The Brightness level, upon initial startup, is set to the last setting that has been loaded into the optional A4 COMM/Bit onboard memory. Increase and decrease functions are controlled thru up/down counters U8 and U9. These counters are used to adjust the level of brightness using hexadecimal output from 0 to 256 bytes. These counters are tied to nand gate U6 and nor gate U7 which are used for setting the upper and lower limits. The outputs from the up/down counters are then processed thru a multiplying digital to analog (DAC) converter (U10). A multiplying DAC is one in which the reference input can be varied, which is being done by a preset potentiometer (R4) which is being used as a preset reference voltage for setting the brightness level. The output signal is the product of the reference input and the inputs from the counter circuitry. This output is then sent to comparator (U15) and compared to a preset voltage (preset at potentiometer R6) which is the shutter offset voltage. Gain is adjusted with resistor R8 to set the reference span. The brightness signal is then sent to the video section of the motor control board (A3).

When the light source is in the Manual mode, the voltage thru resistor R19 is used as a reference voltage for comparator U14A. This voltage is compared, thru comparator U14A, with the brightness signal from the output of comparator U15A. This output is then sent to comparator U14B where it is compared with the shutter positioning potentiometer voltage. Here the signal is amplified and used to drive the servo motor for positioning the shutter.

When the light source is in the Auto mode, the voltage thru resistor R19 is no longer used as a reference voltage. Instead, the signal from the Q output of J-K flip-flop U3A, which is lo, is applied to switch U4 in the video section and pulls it closed. This allows the video signal, which is amplified thru U12, to be compared thru comparator U14A with the brightness signal from the output of comparator U15. This output is then sent to comparator U14B where it is compared with the shutter positioning potentiometer voltage. Likewise, the signal from the Q output of J-K flip-flop U3A, which is lo, is also applied to switch U13B and pulls it closed. The purpose of this switch is to insert resistor R24 in parallel with resistor R23 to decrease the gain of the amplifier circuitry so that the shutter moves in smaller increments. This signal is then processed thru the shutter driver circuitry to position the shutter motor.

Jumper Board - A4 (Standard)

The jumper board (A4) is used in the standard light source (LIS8430/LIS8430E) which does not allow for any of the following:

- Self-Diagnostics
- Remote control features
- Temperature Sensing
- User settings memory retention

COMM/Bit Board - A4 (optional)

The COMM/Bit board (A4) converts the standard light source (LIS8430/LIS8430E) to a light source with the following features (LIS8430W/LIS8430WE):

- Self-Diagnostics
- Remote control features
- Temperature Sensing
- User settings memory retention

The COMM/Bit board contains the communications and diagnostics circuitry for the light source; a 27C512 (U4) EPROM, on board RAM, and a 80C31 CPU. Along with several latches and decoders, this board is used to regulate and control the communications and diagnostics of the light source. The EPROM is programmed with the diagnostics and help information which is processed by the 80C31 CPU to communicate with the

internal circuitry, as well as the LIS8170 Camera consoles, and interpret the onboard diagnostics.

The COMM/Bit board is also equipped with a supervisory circuit (U1) which is used in conjunction with the 80C31 CPU. Some of its functions are: a precision voltage monitor and reset output, power failure warning and write protection of CMOS RAM or EPROM, and low battery detection switchover.

A voltage detector monitors VCC and generates a RESET output to hold the microprocessor's Reset line low when Vcc is below a preset voltage. This prevents repeated toggling of RESET even if the 5V power drops out and recovers with each power line cycle. When a power failure occurs, a non-maskable interrupt is issued to the microprocessor and data is saved to RAM. The battery switchover circuit compares Vcc to the Vbatt input, and connects Vout to whichever is higher.

The COMM/Bit board (A4) also contains temperature sensing circuitry in the event that the cooling fan malfunctions and a build-up of heat is experienced. The temperature sensing range is determined by preset voltages which are derived from the +15VDC supply voltage and a regulated +9VDC regulator. If the sensor registers a voltage outside the upper range then the following diagnostic message will be displayed on the monitor screen: "Light Source Over Temp".

On Board Temperature Sensor

NOTE

This is only applicable if using an LIS8170 Camera console with internal diagnostics and communications capabilities.

Status Indicators

Status indicators on the COMM/Bit board (A4) are used to indicate to the technician that there is a problem with the circuitry on the COMM/bit board. These indicators, a green (D1) and red (D2) diode, will indicate the following states of the board when illuminated in the following pattern:

GREEN	RED	STATE
OFF	OFF	No Power
OFF	ON	Problem Detected
ON	OFF	OK
ON	ON	CPU Run Problem

Block Diagram

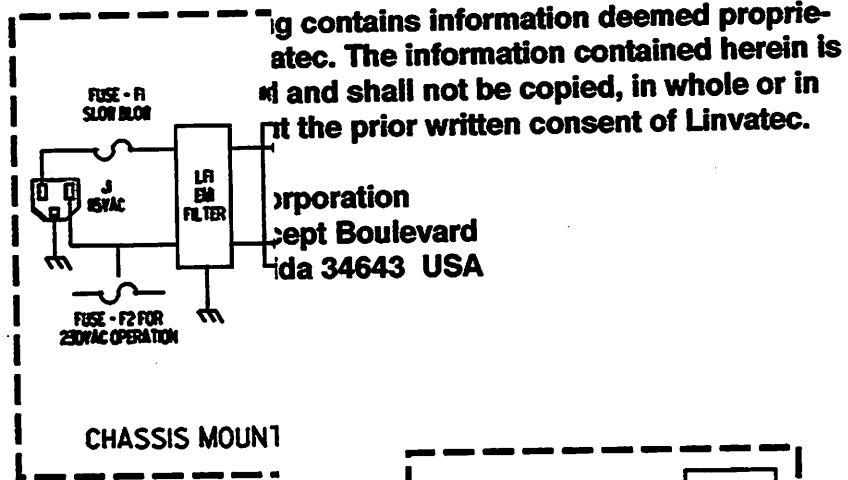

This block contains information deemed proprietary and shall not be copied, in whole or in part, without the prior written consent of Linvatec.

Linvatec Corporation
 10000 North Boulevard
 Santa Fe, NM 87504 USA

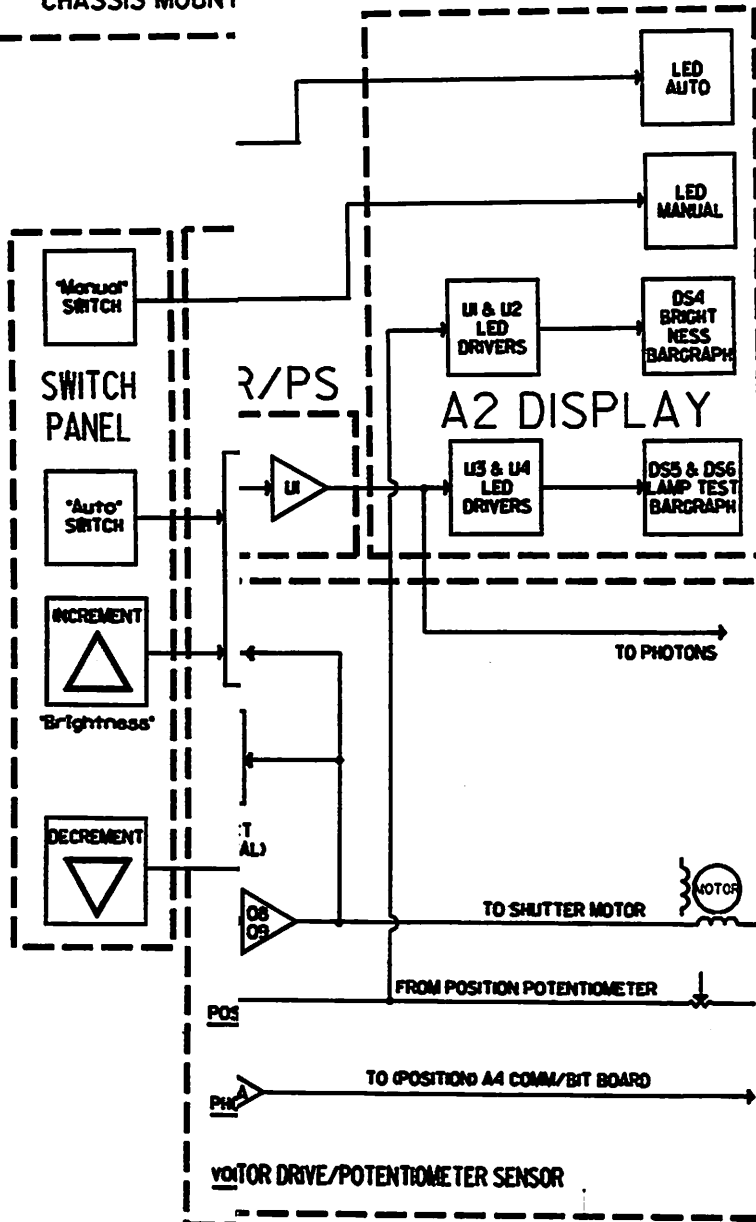

**E INTENTIONALLY
FT BLANK**

Theory of Operation & Schematics

LIS8430 Xenon
Light Source

Chassis Component Layout Topview

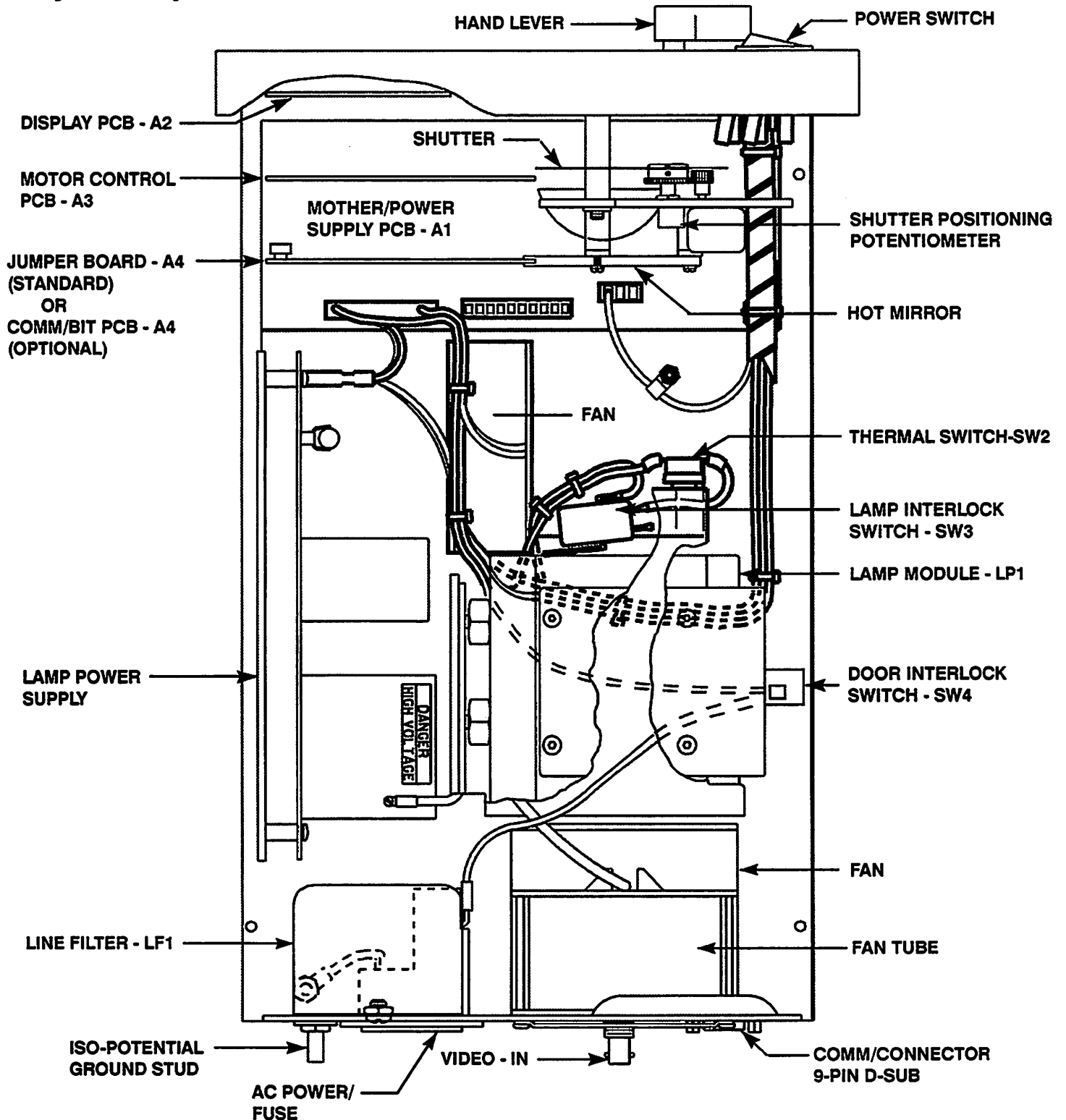

Theory of Operation & Schematics

LIS8430 Xenon
Light Source

**THIS PAGE INTENTIONALLY
LEFT BLANK**

System Interconnect

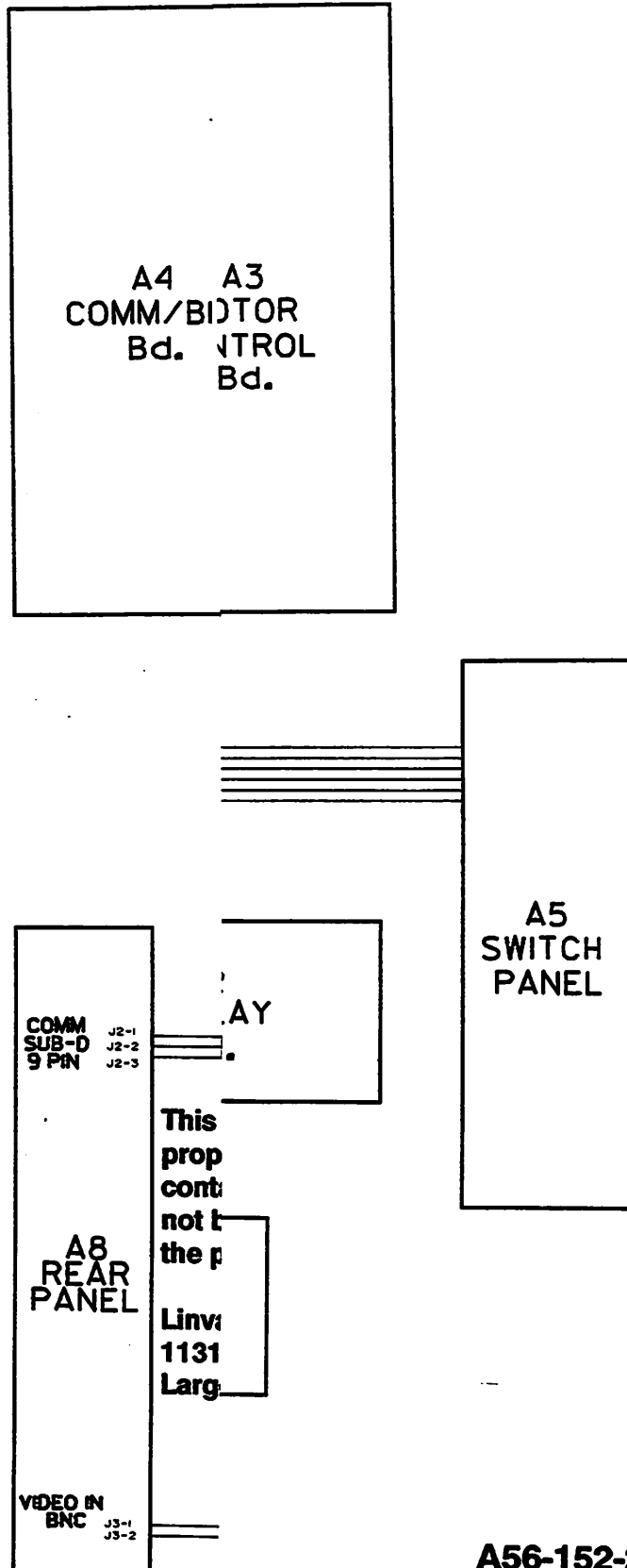

**E INTENTIONALLY
FT BLANK**

Theory of Operation & Schematics

LIS8430 Xenon
Light Source

Mains Interconnect

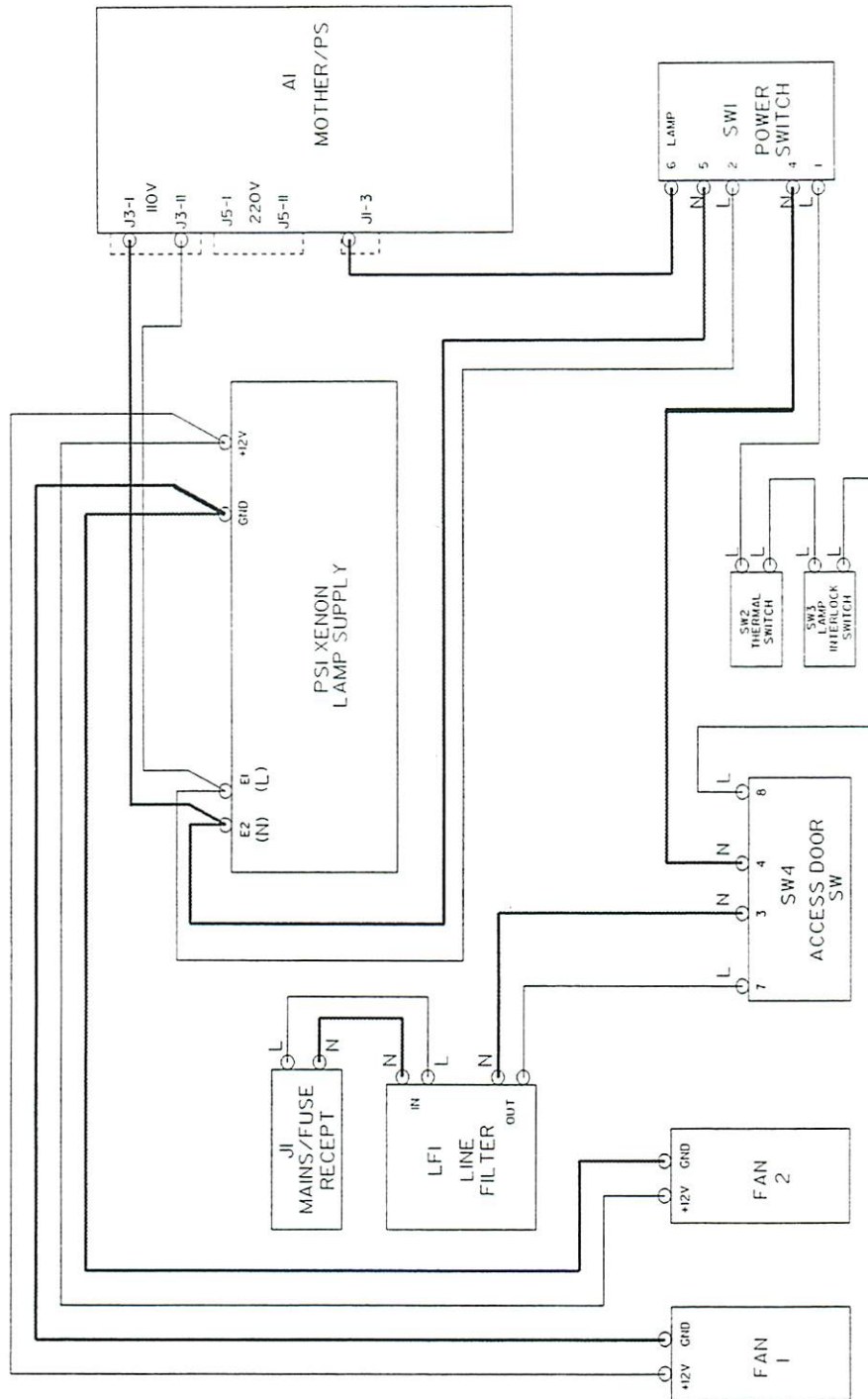

Note: () Designates Walker Power Supply.

A56-152-201 Rev. A

Theory of Operation & Schematics

LIS8430 Xenon
Light Source

Mother/Power Supply Board Assembly - A1

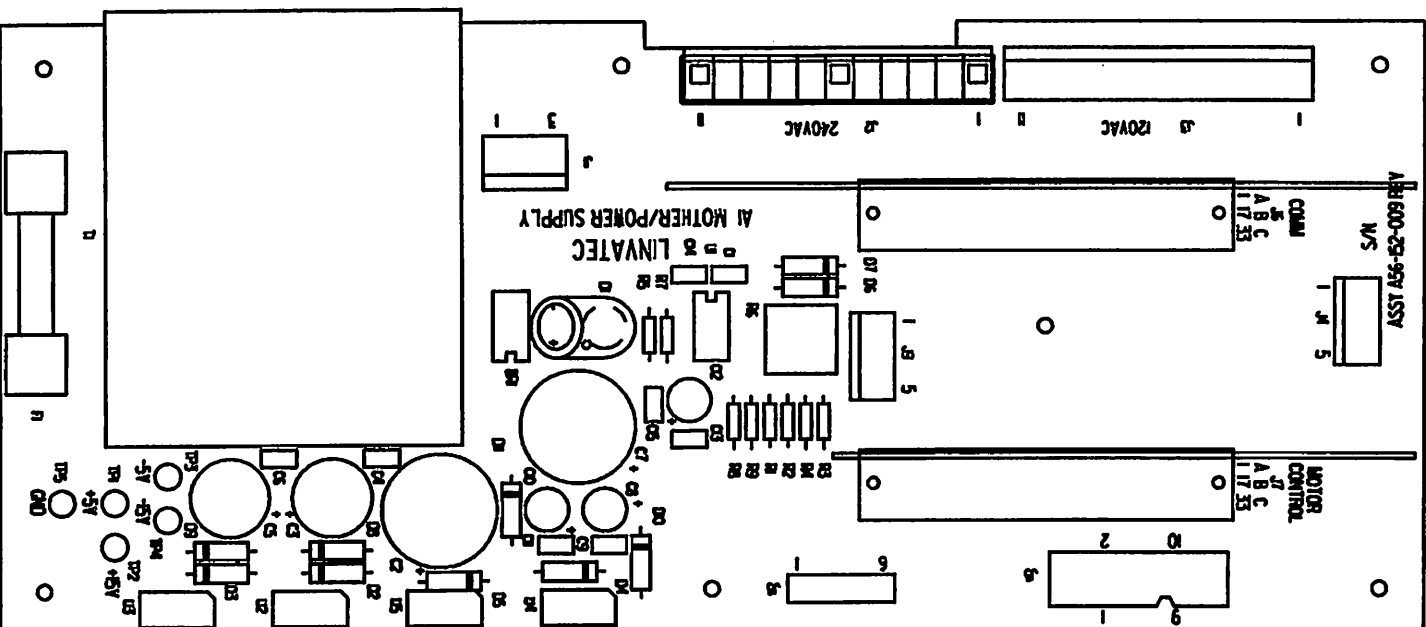

Theory of Operation & S

LIS8430 Xenon
Light Source

Mother/Power Supply Board - A1 Schematic

TO SWITCH LAMP

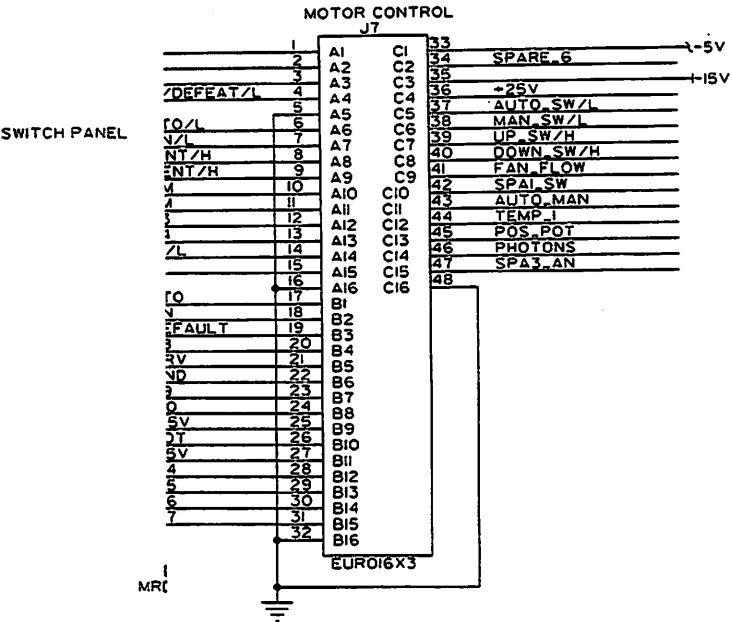
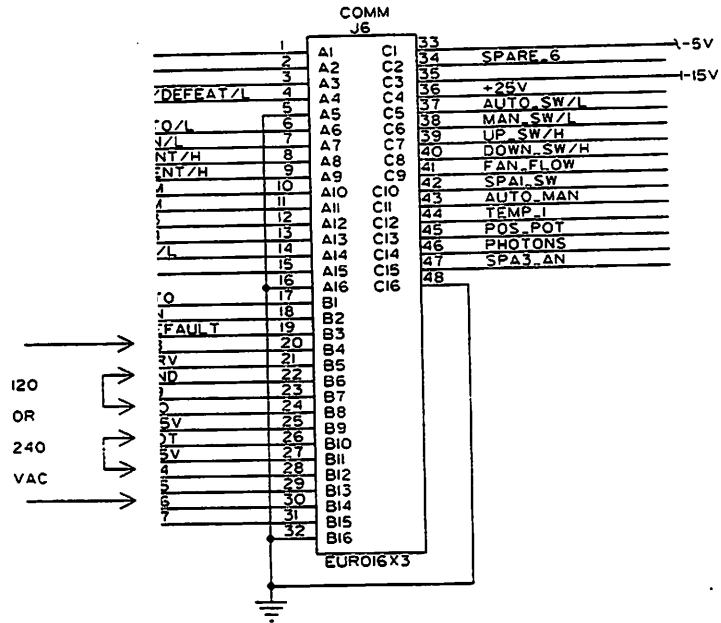

SWITCH PANEL

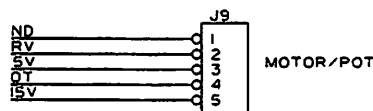
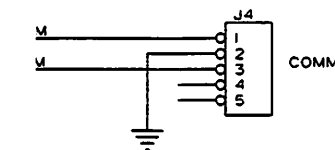

This drawing contains information deemed proprietary to Linvatec. The information contained herein is confidential and shall not be copied, in whole or in part, without the prior written consent of Linvatec.

Linvatec Corporation
11311 Concept Boulevard
Largo, Florida 34643 USA

A56-152-209 Rev. C

**INTENTIONALLY
LEFT BLANK**

Display Board Assembly - A2

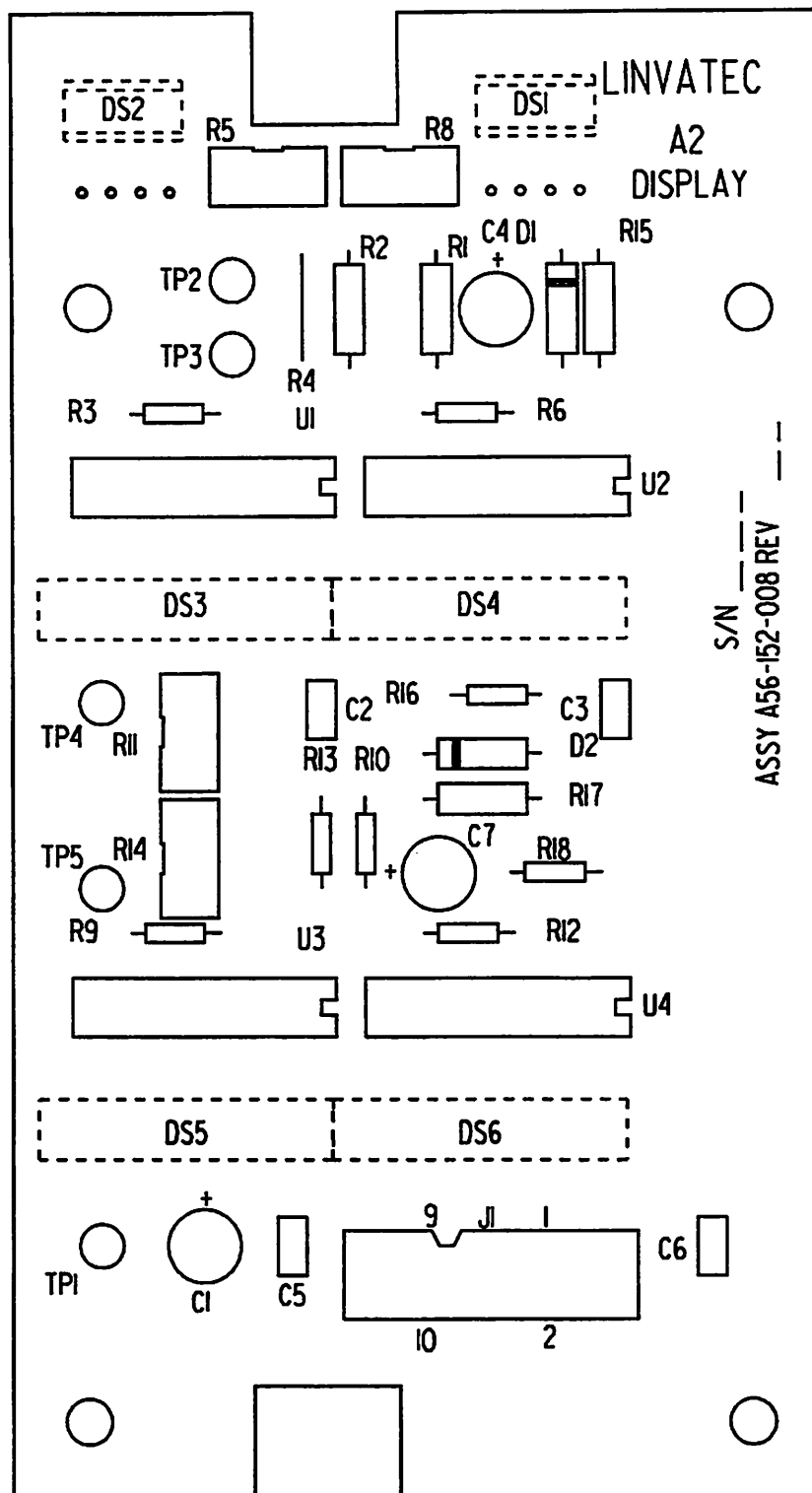

Theory of Operation & Schematics

LIS8430 Xenon
Light Source

Display Board - A2 Schematic

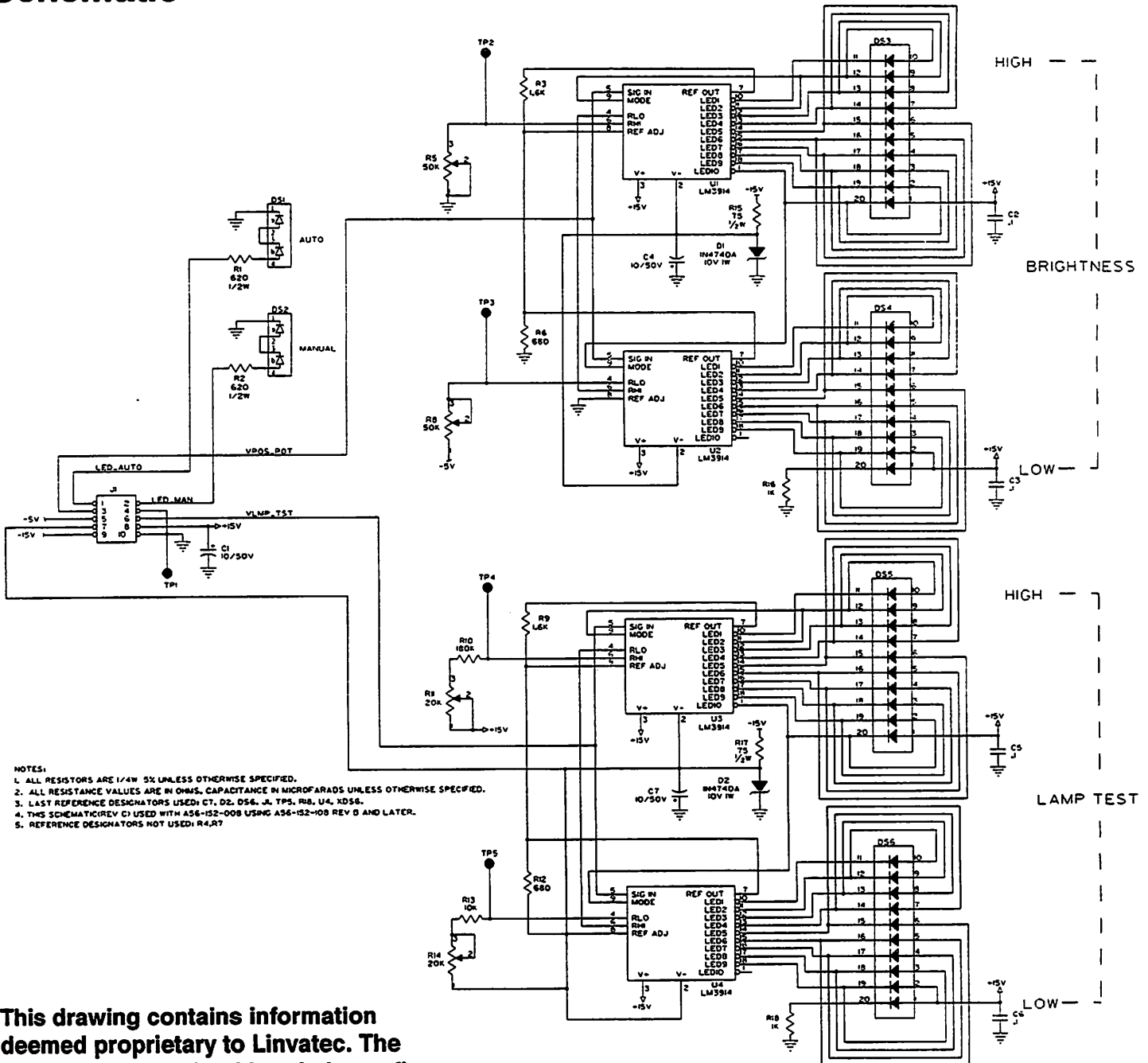

- NOTES:
1. ALL RESISTORS ARE 1/4W 5% UNLESS OTHERWISE SPECIFIED.
 2. ALL RESISTANCE VALUES ARE IN OHMS, CAPACITANCE IN MICROFARADS UNLESS OTHERWISE SPECIFIED.
 3. LAST REFERENCE DESIGNATORS USED: CT, D2, D56, J, TP5, RB, U4, KD56.
 4. THIS SCHEMATIC (REV C) USED WITH A56-152-008 USING A56-152-108 REV B AND LATER.
 5. REFERENCE DESIGNATORS NOT USED: R4, R7.

This drawing contains information deemed proprietary to Linvatec. The information contained herein is confidential and shall not be copied, in whole or in part, without the prior written consent of Linvatec.

Linvatec Corporation
11311 Concept Boulevard
Largo, Florida 34643 USA

A56-152-208 Rev. C

Theory of Operation & Schematics

LIS8430 Xenon
Light Source

Motor Control Board Assembly - A3

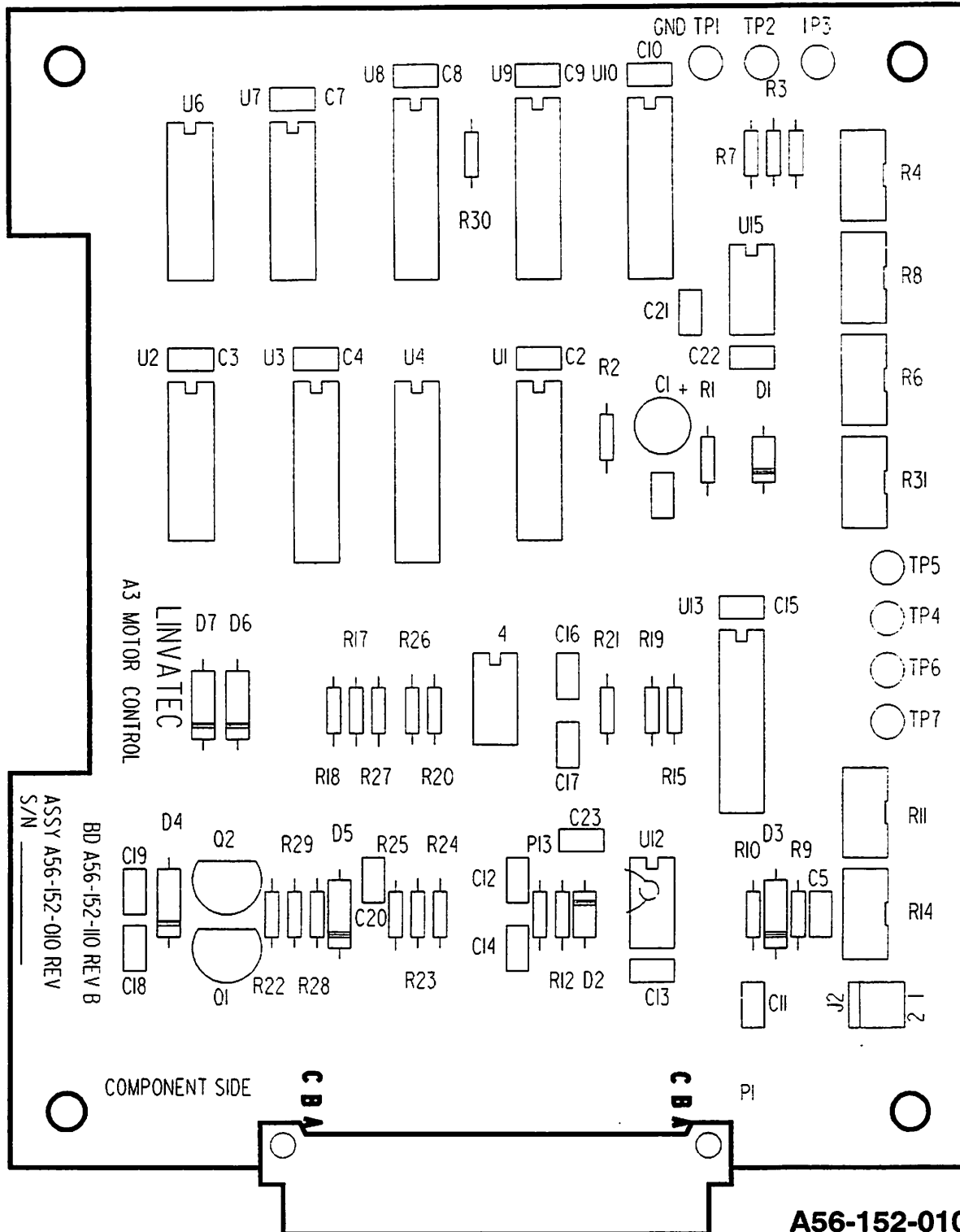

Theory of Operation & Schematics

LIS8430 Xenon
Light Source

**THIS PAGE INTENTIONALLY
LEFT BLANK**

Theory of Operation & S

Motor Control Board - A3 Schematic

This drawing contains information deemed proprietary to Linvatec. The information contained herein is confidential and shall not be copied, in whole or in part, without the prior written consent of Linvatec.

Linvatec Corporation
11311 Concept Boulevard
Largo, Florida 34643 USA

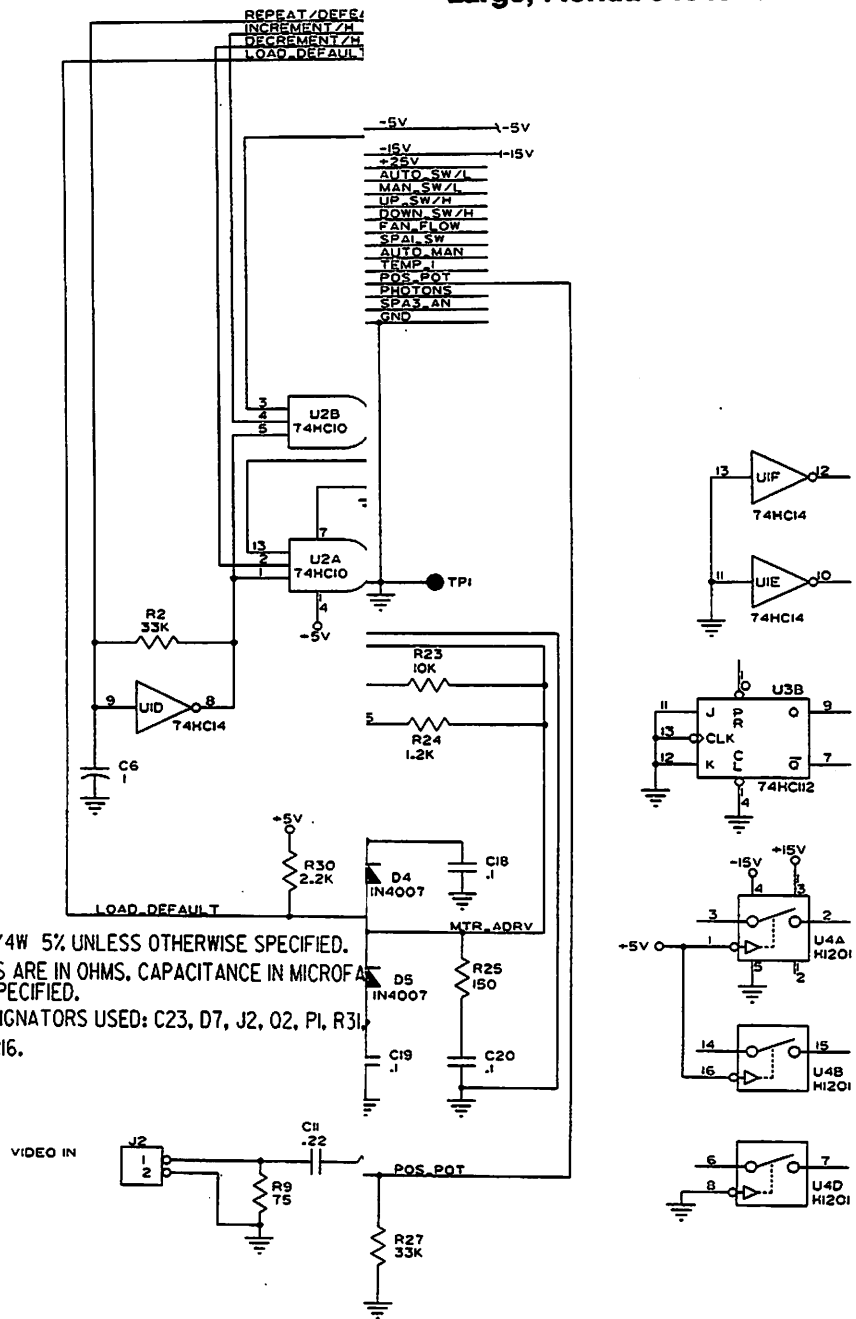
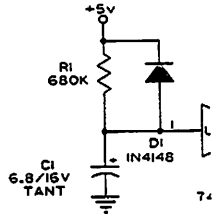

NOTES:

1. ALL RESISTORS ARE 1/4W 5% UNLESS OTHERWISE SPECIFIED.
2. ALL RESISTOR VALUES ARE IN OHMS, CAPACITANCE IN MICROFARADS UNLESS OTHERWISE SPECIFIED.
3. LAST REFERENCE DESIGNATORS USED: C23, D7, J2, O2, P1, R31.
4. NOT USED U11, U5, J1, R16.

**INTENTIONALLY
NOT BLANK**

Theory of Operation & Schematics

LIS8430 Xenon
Light Source

COMM/Bit Board Assembly - A4 (Optional)

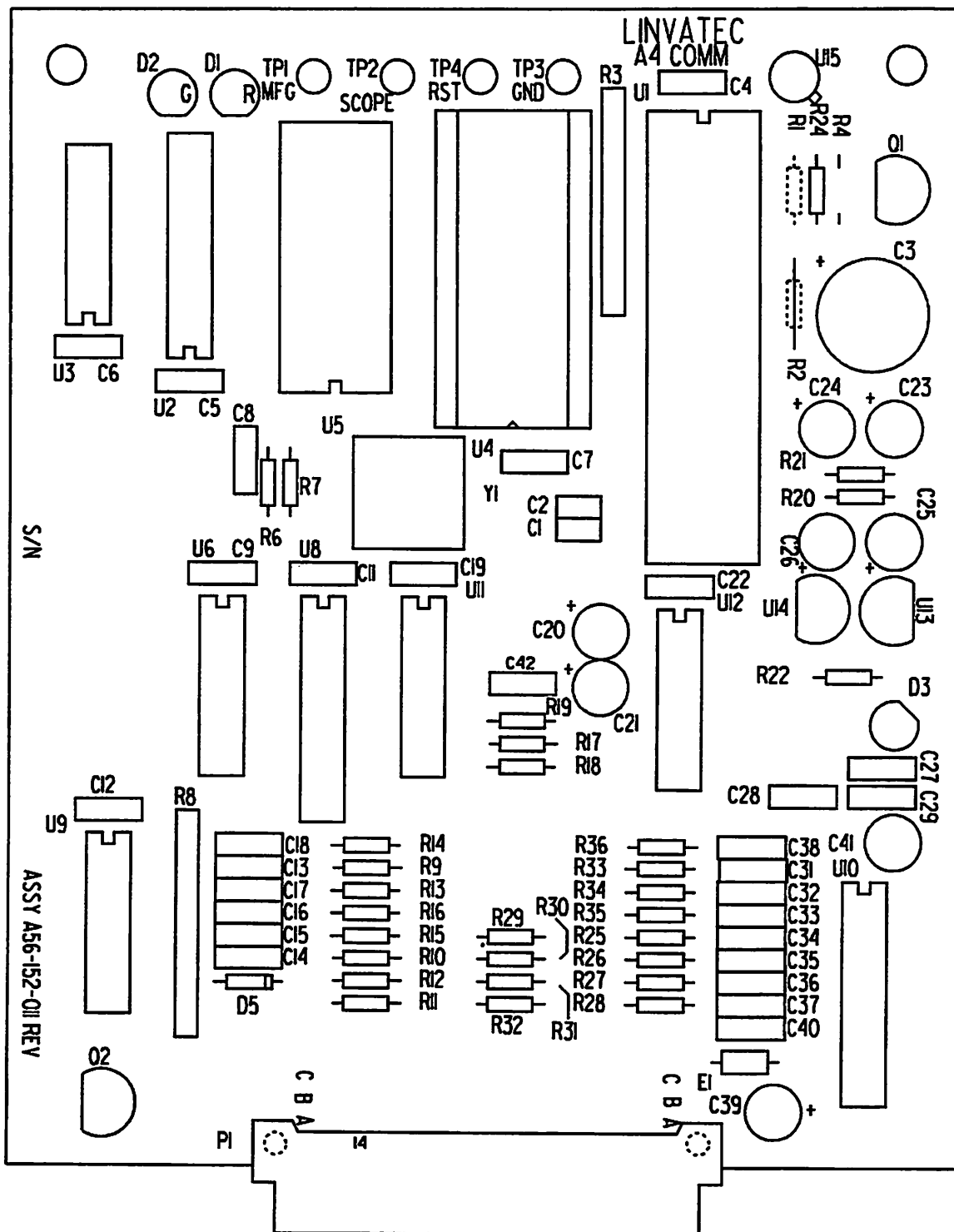

A56-152-011 Rev. K

Theory of Operation & Schematics

LIS8430 Xenon
Light Source

**THIS PAGE INTENTIONALLY
LEFT BLANK**

Theory of Operation & S

LIS8430 Xenon
Light Source

COMM/Bit Board - A4 Schematic (Optional)

This drawing contains information deemed proprietary to Linvatec. The information contained herein is confidential and shall not be copied, in whole or in part, without the prior written consent of Linvatec.

Linvatec Corporation
3111 Concept Boulevard
Orlando, Florida 32803 USA

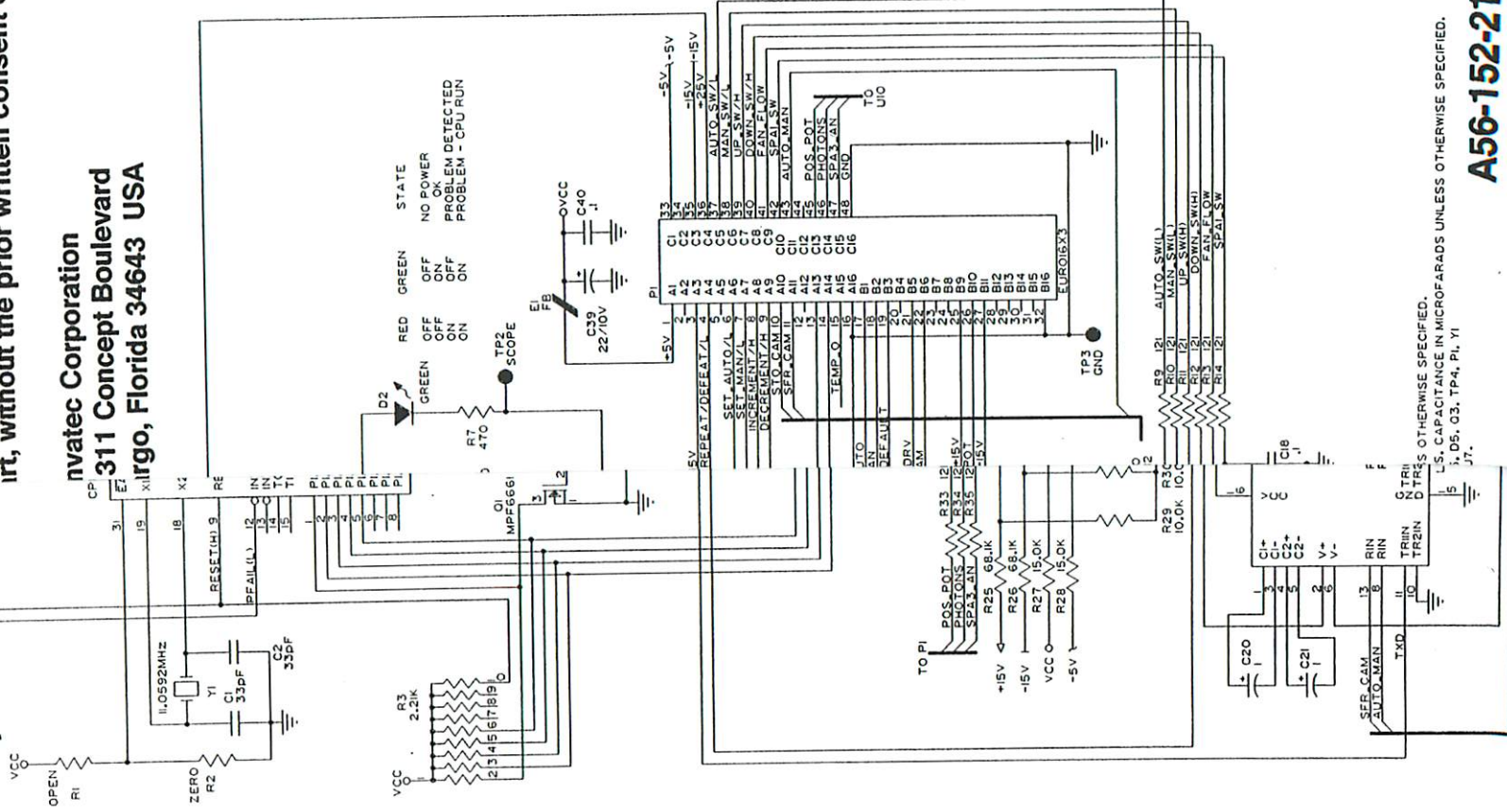

RESISTOR VALUES OTHERWISE SPECIFIED.
CAPACITANCE IN MICROFARADS UNLESS OTHERWISE SPECIFIED.
1, 05, 03, TP4, PL, Y1, J7.

A56-152-211 Rev. D

**INTENTIONALLY
LEFT BLANK**

Theory of Operation & Schematics

LIS8430 Xenon
Light Source

Jumper Board Assembly - A4 (Standard)

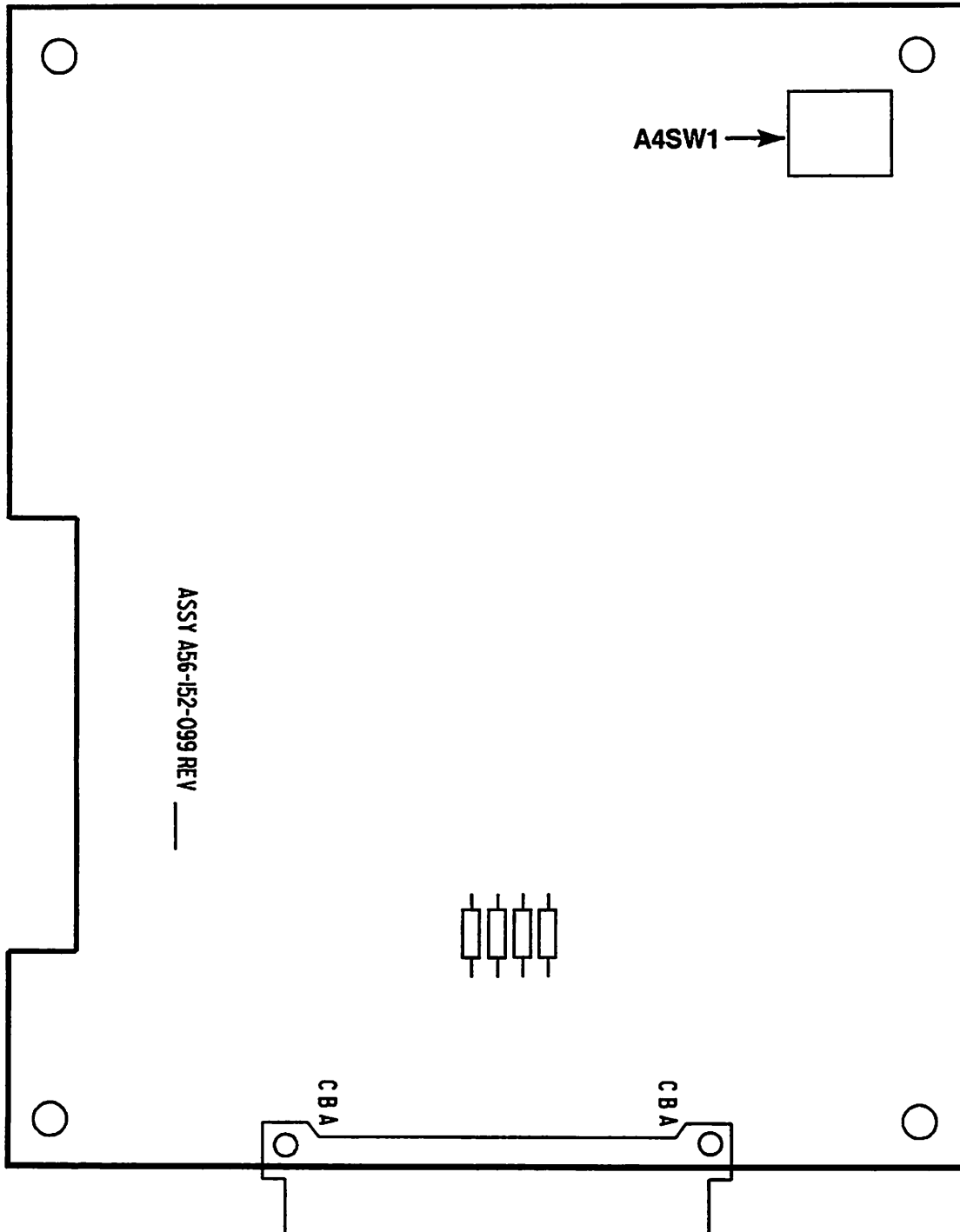

A56-152-099 Rev. A

Theory of Operation & Schematics

LIS8430 Xenon
Light Source

Jumper Board - A4 Schematic (Standard)

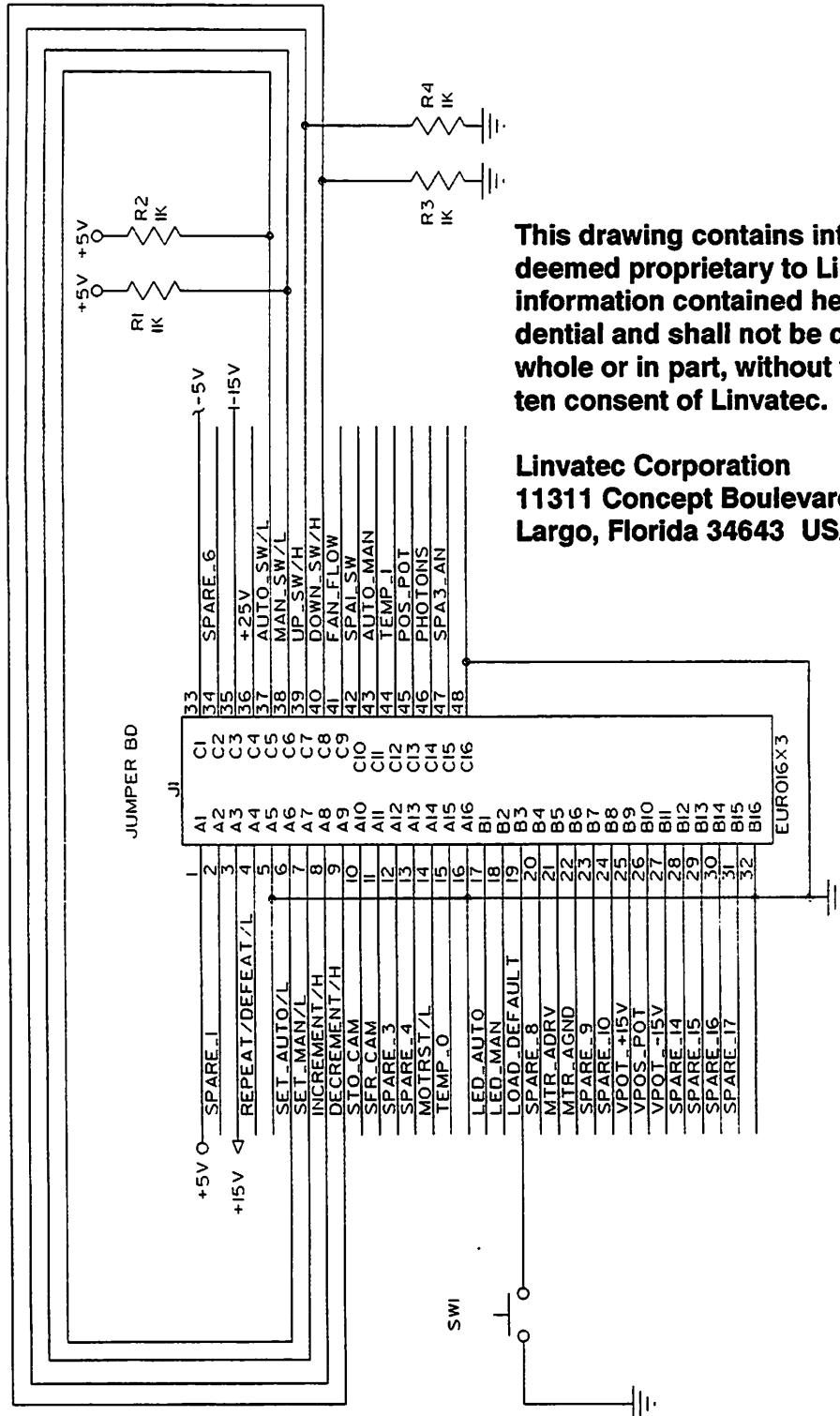

This drawing contains information deemed proprietary to Linvatec. The information contained herein is confidential and shall not be copied, in whole or in part, without the prior written consent of Linvatec.

Linvatec Corporation
11311 Concept Boulevard
Largo, Florida 34643 USA

Service Information

LIS8430 Xenon
Light Source

Care and Handling of CMOS Logic

Most logic elements used in this instrument are fabricated using monolithic Complementary Metal Oxide/Silicone technology (CMOS). The N and P channel enhancement mode transistors used provide symmetrical circuits with output swings essentially equal to the supply voltage. This results in high noise immunity equal to approximately 45% of the supply voltage. This is the desired feature for instruments that must operate in a high noise environment.

No DC power other than that caused by leakage is consumed during static conditions. Thus, the devices run very cool which results in longer life and higher reliability. All of the inputs are protected against static discharge and latching conditions.

Although precautions have been taken in the design of the logic elements, it is still possible they may be damaged by electrostatic discharge during handling. Therefore, the following procedures should be adhered to when working with all CMOS logic elements:

1. Work on a grounded surface when handling any CMOS logic elements, identifiable by "4000", "74AC" or "74HC" series numbers.
2. When soldering on any CMOS board, use only antistatic type solder-suckers and grounded-tip soldering irons.
3. Avoid plastic, vinyl, and styrofoam in work area.

Replacement Parts

To obtain replacement parts or accessories for the Linvatec LIS8430 Light Source, please contact your local Linvatec Sales/Service Representative or contact:

Linvatec

Attn: Customer Service Dept.

**11311 Concept Boulevard
Largo, Florida 34643**

**Phone 800-237-0169
FAX: 813-399-5256**

International Department

**Phone: 813-392-6464
FAX: 813-397-4540**

When ordering spare parts or replacement parts, please supply the following information:

1. Instrument model/serial number.
2. Component description.
3. Quantity desired.
4. Linvatec part number.
5. Component reference designator (if applicable).

Service Information

LIS8430 Xenon
Light Source

Recommended Spare Parts

<u>Recommended Quantity</u>	<u>Description</u>	<u>Reference Designator</u>	<u>Linvatec Part No.</u>
1	BNC Cable	-	E52-075
1	Lamp Module	LP1	Cat. # 8431
4	Feet, Rubber	-	H50-052
1	Hand Lever	-	A56-097-075
1	Filter, Hot Mirror	-	L30-001
2	Regulator, Voltage, +5V	U2	E40-108
2	Regulator, Voltage, -5V	U4	E40-159
2	Regulator, Voltage, +15V	U3	E40-126
2	Regulator, Voltage, -15V	U5	E40-130
2	Regulator, Voltage MC7805CP, +5 volt	U13	E40-170
2	Regulator, Voltage MC7905CP, -5 volt	U14	E40-169
2	Diode, Voltage Reference LM185H-2.5	D3	E40-171
1	Bridge Rectifier, 1 Amp VM18	BR1	E40-153
2	Transistor, MPF6661	Q1-Q3	E42-141
2	Transistor, MPSW06, NPN	Q1	E42-142
2	Transistor, MPSW56, PNP	Q2	E42-143
1	Temperature Sensor LM134	U15	E60-270
1	Switch, Limit	-	E60-268
1	Switch, Interlock	-	E60-267

Service Information

LIS8430 Xenon
Light Source

Recommended Spare Parts (continued)

<u>Recommended Quantity</u>	<u>Description</u>	<u>Reference Designator</u>	<u>Linvatec Part No.</u>
1	Switch, Thermo	-	E60-269
1	Photo Detector Diode, MRD-510	D1	E45-016
1	Mains Power Cord (NTSC)	-	E55-015
1	Mains Power Cord (PAL)	-	E55-016
2	Fuse, 8 Amp, 250V (LIS8430/LIS8430W — 100/120V)	F1	E67-067
4	Fuse, 8 Amp, 250V (LIS8430E/LIS8430WE — 220/240V)	F1	E67-069
4	Fuse, T0.187A, 250V (Mother/Power Supply Board) (110/120V)	F1	E67-071
4	Fuse, T0.16A, 250V (Mother/Power Supply Board) (220/240V)	F1	E67-043

Service Information

LIS8430 Xenon
Light Source

Chassis Parts

<u>Description</u>	<u>Reference Designator</u>	<u>Lintratec Part No.</u>
Mother/Power Supply PCB Assy.	A1	A56-152-119
Display PCB Assembly	A2	A56-152-008
Motor Control PCB Assembly	A3	A56-152-010
COMM/Bit Channel PCB Assembly	A4	A56-152-011
Front Universal Guide Mount, 8430	-	A56-152-007
Switch Panel	-	A56-152-102
Power Cord (100/120V)	-	E55-015
Power Cord (220/240V)	-	E55-016
Fans, 12VDC	-	A56-152-018
Guard, Fan	-	A56-152-142
Exhaust Fan Tube	-	A56-152-014
Switch, DPST Power	SW1	E60-266
Power Entry/Fuse Receptacle	J1	E52-140
Fuse Drawer (Domestic)	-	E52-141
Fuse Drawer (International)	-	E52-142
Connector, 9-pin, D-sub	J2	E52-139
Receptacle, BNC	J3	E52-074
EMI Filter	LF1	E70-027
Lamp Power Supply	PS1	A56-152-017
Power Supply Bracket	-	A56-152-020
Lamp Housing Support Assembly	-	A56-152-012
ISO-Potential Post	-	E50-680
Interlock Switch	-	E60-267
Micro Switch	-	E60-268
Thermo Switch	-	E60-269
Hand Lever	-	A56-097-075
Servo Motor	-	A56-152-160
Servo Motor Housing	-	A56-152-161
Shutter	-	A56-152-162
Shutter Gear	-	A56-152-163
Shutter Motor	-	A56-152-165
Condenser Lens	-	L35-406
Filter, Hot Mirror	-	L30-001
Potentiometer, 2.5K	-	E03-262
Cover, 8430	-	A56-152-104
Base, 8430	-	A56-152-103
Harness, Power Supply	-	A56-152-033
Harness, S1 to Ji	-	A56-152-034
Harness, S1 to S2	-	A56-152-035
Harness, COMM Cable	-	A56-152-036
Harness, Video In	-	A56-152-038
Harness, Display to Mother Board	-	A56-152-039
Harness, Fuse Holder	-	A56-152-040
Harness, Thermostat	-	A56-152-042
Harness, Servo Motor	-	A56-152-043

Service Information

LIS8430 Xenon
Light Source

Mother/Power Supply Board Components - A1

<u>Description</u>	<u>Reference Designator</u>	<u>Linvatec Part No.</u>
Capacitor .1 μ fd 50V	C1, C4, C6, C9, C11, C13, C14	E10-204
Capacitor 10 μ fd 50V	C8, C10, C12	E11-303
Capacitor 47 μ fd 25V	C3, C5	E11-304
Capacitor 1000 μ fd 35V	C2, C7	E17-706
Diode, 1N4007	D2-D5	E40-165
Diode, Zener 4.3V, 1N4731	D6, D7	E40-167
Diode, Transorb, SA5.0A, 5V	D8, D10	E40-119
Diode, Transorb, SA15, 15V	D9, D11	E40-135
Fuse, T0.187A, 250V (100/120V)	F1	E67-071
Fuse, T0.16A, 250V (220/240V)	F1	E67-043
IC Dual Op-Amp, MC1458	U1	E44-143
Photo Detector, MRD510	D1	E45-016
Potentiometer 1M	R6	E03-266
Rectifier, Bridge, VM18	BR1	E40-153
Resistor 1K 1/4W 5%	R1-R4	E06-207
Resistor 2.7K 1/4W 5%	R9	E06-209
Resistor 10K 1/4W 5%	R8	E06-212
Resistor 470K 1/4W 5%	R7	E06-272
Resistor 1M 1/4W 5%	R5	E06-238
Test Point	TP1-TP4, TP5A, TP5B, TP6	E50-656
Transformer, Signal 12VA	T1	E70-024
Regulator, Voltage +5V	U2	E40-108
Regulator, Voltage -5V	U4	E40-159
Regulator, Voltage +15V	U3	E40-126
Regulator, Voltage -15V	U5	E40-130
Header, .1 sq. 5 pin	J4, J9	E52-116
Header, .1 sq. 6 pin	J8	E52-123
Header, 3 pos with ramp	J1	E53-187
Header, 11 pos with ramp	J2, J3	E53-186
Header, .1 sq. 5x2	J5	E53-184
Connector Euro-DW 16x3	J6, J7	E53-624

Service Information

LIS8430 Xenon
Light Source

Display Board Components - A2

<u>Description</u>	<u>Reference Designator</u>	<u>Lintratec Part No.</u>
Capacitor .1 μ fd 50V	C2, C3, C5, C6	E10-204
Capacitor 10 μ fd 50V	C1, C4, C7	E11-303
Diode, Zener 1N4740A, 10V, 1W	D1, D2	E40-173
IC LED Driver LM3914	U1-U4	E44-035
LED Dual, Yellow	DS1, DS2	E32-434
LED Bar, Yellow-10 Segment	DS3-DS6	E32-435
Potentiometer 20K	R11, R14	E03-268
Potentiometer 50K	R5, R8	E03-269
Resistor 75 1/2W, 5%	R15, R17	E06-757
Resistor 620 1/2W 5%	R1, R2	E06-741
Resistor 680 1/4W 5%	R6, R12	E06-206
Resistor 1K 1/4W 5%	R16, R18	E06-207
Resistor 1.6K 1/4W 5%	R3, R9	E06-742
Resistor 10K 1/4W 5%	R13	E06-212
Resistor 180K 1/4W 5%	R10	E06-093
Socket Sip .1 sq 20 pin	XDS1, XDS2	E53-191
Socket, Sip .1 sq. 4 pin	XDS2-XDS6	E53-183
Test Point	TP1-TP5	E50-656
Header 10 pin dual row	J1	E53-184

Service Information

LIS8430 Xenon
Light Source

Motor Control Board Components A3

<u>Description</u>	<u>Reference Designator</u>	<u>Lintratec Part No.</u>
Capacitor 150pfd 50V	C23	E10-207
Capacitor 680pfd 50V	C14	E10-237
Capacitor .047 μ fd 50V	C5	E10-208
Capacitor .1 μ fd 50V	C2-C4, C7-C9, C12, C13, C15-C22	E10-204
Capacitor .01 μ fd 50V	C10	E10-205
Capacitor .22 μ fd 50V	C11	E10-228
Capacitor 50 μ fd 100V	C6	E10-240
Capacitor 6.8 μ fd 35V	C1	E11-338
Diode, 1N4148	D1, D2	E40-146
Diode, 1N4007	D4, D5	E40-165
Diode, Zener 4.3V, 1N4731A	D6, D7	E40-167
Diode, Zener 5.1V, 1N4733A	D3	E40-168
IC 74HC193	U8, U9	E44-092
IC Hex Inverting Schmitt Trigger 74HC14	U1	E44-110
IC Dual Op-Amp LM1458	U12, U14, U15	E44-143
IC 3-Input Dual Nand Gate 74HC10	U2	E44-188
IC 8-Input Nand 74HC30	U6	E44-189
IC Dual J-K Flip-Flop 74HC112	U3	E44-190
IC 8-Input Nor/Or Gate 74HC4078	U7	E44-191
IC Analog Switch HI-201	U4, U13	E44-192
IC Digital to Analog Converter DAC-08	U10	E44-193
Potentiometer 5K	R8	E03-272
Potentiometer 10K	R4, R6, R11, R31	E03-267
Potentiometer 100K	R14	E03-264
Resistor 75 1/4W 5%	R9	E06-291
Resistor 150 1/4W 5%	R25	E06-247
Resistor 330 1/4W 5%	R10	E06-745
Resistor 470 1/4W 5%	R22	E06-240
Resistor 1K 1/4W 5%	R21	E06-207
Resistor 1.2K 1/4W 5%	R24	E06-255
Resistor 2.2K 1/4W 5%	R30	E06-208
Resistor 3.74K 1/4W 1%	R29	E06-106
Resistor 4.99K 1/4W 1%	R3, R7	E06-743
Resistor 6.19K 1/4W 1%	R28	E06-308
Resistor 10K 1/4W 5%	R23	E06-212
Resistor 15K 1/4W 5%	R13	E06-246
Resistor 27K 1/4W 1%	R5	E06-214
Resistor 33K 1/4W 5%	R2, R26, R27	E06-215
Resistor 47K 1/4W 5%	R15, R17	E06-216
Resistor 100K 1/4W 5%	R19	E06-217

Service Information

LIS8430 Xenon
Light Source

Motor Control Board Components - A3 (continued)

<u>Description</u>	<u>Reference Designator</u>	<u>Linvatec Part No.</u>
Resistor 180K 1/4W 5%	R18, R20	E06-093
Resistor 200K 1/4W 5%	R12	E06-746
Resistor 680K 1/4W 5%	R1	E06-081
Transistor NPN, MPSW06	Q1	E42-142
Transistor PNP, MPSW56	Q2	E42-143
Test Point	TP1-TP7	E50-656
Header .1 ctr. 2 pin sq.	J2	E52-121
Connector Euro Din 16 x 3	P1	E53-625

Service Information

LIS8430 Xenon
Light Source

COMM/Bit Board Components - A4

<u>Description</u>	<u>Reference Designator</u>	<u>Lintratec Part No.</u>
Capacitor 33pfd 50V	C1, C2	E10-227
Capacitor .01 μ fd 100V	C42	E16-007
Capacitor .033 μ fd 5.5V	C3	E10-238
Capacitor .1 μ fd 50V	C4-C9, C11-C19, C22, C27-C29, C31-C38, C40	E16-008
Capacitor 1 μ fd 35V	C20, C21, C23-C26	E11-312
Capacitor 22 μ fd 10V	C39, C41	E11-308
Crystal 11.0592MHz HC-18	Y1	E44-184
Ferrite Bead EXC-ELSA35	E1	E15-219
Diode, Voltage Reference 2.5V LM185H-2.5	D3	E40-171
Diode, 1N4148	D5	E40-146
Voltage Regulator - 5V, 79L05	U14	E40-169
Voltage Regulator + 5V, 78L05	U13	E40-170
IC Dual 2-4 Line Decoder 74HC139	U3	E44-133
IC Microprocessor Supervisory Circuits MAX691EPE	U11	E44-167
IC CMOS Single-chip 8-bit Control Oriented CPU with RAM and I/O P80C31BH	U1	E44-168
IC EPROM Programmed	U4	A56-152-030
IC 16K Nonvolatile SRAM DS1220AD-150-IND	U5	E44-170
IC RS232 Dual Driver/Receiver LT1081	U12	E44-171
IC 10-bit Data Acquisition System LTC1090ACN	U10	E44-172
IC Quad 2-Channel Tri-state Multiplexer 74HC257	U9	E44-179
IC 8-bit Addressable Latch/ 3-8 Line Decoder 74HC259	U6	E44-180
IC Octal D-type Latch 74HC373	U2, U8	E44-073
IC Constant Current Source and Temperature Sensor LM134H-3	U15	E60-270
LED, Red	D1	E32-402
LED, Green	D2	E32-431
Resistor 75 1/4W 5%	R20, R21	E06-291
Resistor 121 1/4W 1%	R9-R14, R33-R35	E06-728
Resistor 226 1/4W 1%	R24	E06-740
Resistor 430 1/4W 5%	R6	E06-730
Resistor 470 1/4W 5%	R7	E06-240

Service Information

LIS8430 Xenon
Light Source

COMM/Bit Board Components - A4 (continued)

<u>Description</u>	<u>Reference Designator</u>	<u>Linvatec Part No.</u>
Resistor 2.2K 1/8W 2% Sip	R3, R8	E04-005
Resistor 2.21K 1/4W 1%	R15, R16, R22	E06-735
Resistor 4.02K 1/4W 1%	R36	E06-748
Resistor 4.99K 1/4W 1%	R4, R19	E06-743
Resistor 10K 1/4W 1%	R18, R29-R32	E06-736
Resistor 15K 1/4W 1%	R27, R28	E06-737
Resistor 68.1K 1/4W 1%	R17, R25, R26	E06-738
Transistor MPF6661	Q1-Q2	E42-141
Test Point	TP1-TP4	E50-656
Socket 28-pin Dip	XU4	E49-428
Connector Euro Din, 16 x 3	P1	E53-625

Service Information

LIS8430 Xenon
Light Source

Technical Specifications

I.E.C Equipment Classification

Type B Class 1

Input Power Requirements

Parameter	LIS8430/W	LIS8430E/WE
Voltage	115 V~	230 V~
Frequency	50/60 Hz	50/60 Hz
Max. Current	6.5 A	4.0 A
Fuse	T8.0A	T4.0A

Low Frequency Leakage

Chassis to ground <100 μ A <500 μ A

Video Input

NTSC/PAL Composite Video Signal

BNC connector

Level	1.0 Vp-p	1.0 Vp-p
Impedance	75 Ω	75 Ω

COMM Channel

To RS-232-C

Lamp

Xenon Cermax¹® 300W
Filtered Color Temperature — 5600K (Daylight Color)

Light Guide Receptacle

UNIVERSAL. Will adapt to most light guides.

Environmental

Ambient Operating Temperature: - 14°F to 104°F (-10°C to 40°C).

Relative Humidity - 25% to 85% RH



CAUTION

Do not immerse unit into ANY liquid!

Dimensions

10.0" (W) x 7.0" (H) x 16.1" (D)
[25.4cm (W) x 17.8cm (H) x 40.9cm (D)]

Weight

Approximately 17.8 lbs. (7.71 kg)

¹ CERMAX is a registered trademark of ILC Technology Inc.

Error Messages

This appendix describes error messages which may be encountered while using the LIS8430W/LIS8430WE Xenon Light Source, which employs the communication board, in conjunction with the LIS8170 Self-diagnostic Camera consoles (These messages will not apply if using the LIS8430/LIS8430E Light Source or a different model of camera).

Light Source Test Fail: This error message indicates a light source system failure (the light source may still be used, but will not have any communications for diagnostics with the LIS8170 camera). Power the system OFF and then ON again. The camera will start its internal self-test and will take approximately one (1) minute to finish. If the **Light Source Test Fail** message is displayed again, return to Linvatec for service.

L. S. Communication Error: This error message indicates that there is no communication between the light source communications channel and the LIS8170 Self-Diagnostic Camera. Perform the following before calling or returning the light source to Linvatec:

1. Power the system OFF and then ON. The camera will initiate its self-test and will take approximately one (1) minute to complete. If the **L. S. Communication Error** message is displayed again, go to step 2.
2. If all the components on the light source are working properly, a possible problem is the 9 pin D-sub video communication cable assembly on the rear of the LIS8170 camera. Turn the system OFF and replace the video communication cable assembly with a known working cable assembly. Power the system ON and wait for the internal self-test to complete. If the **L. S. Communication Error** message is displayed again, have the unit serviced by a qualified technician or return to Linvatec.

Light Intensity Low: This error message indicates that the intensity of the lamp is low and the lamp module should be replaced as soon as possible.

Light Source Lamp Fail: This error message indicates that the lamp has expired. Have the lamp module replaced.

Light Source Over Temp: This error message indicates that the light source is overheating. Possible causes may be 1) a fan failure or 2) air ventilation blockage. Perform the following:

Appendix I - Error Messages

LIS8430 Xenon
Light Source

1. Check the clearance around the ventilation ports on the light source chassis. Remove any obstructions which may be inhibiting air flow.
2. Power the system OFF and let it cool down for approximately ten (10) minutes. Power back ON and check for proper operation with no overheating error message. If error message is displayed again, have the unit serviced by a qualified technician or return to Linatec.

Light Source Power Fail: This error message indicates that the internal power supply has failed. Have the unit serviced by a qualified technician or return to Linatec.

L. S. Shutter Fail: This error message indicates that the automatic shutter has failed. Have the unit serviced by a qualified technician or return to Linatec.

L. S. Panel Switch Fail: This error message indicates that a front panel switch is permanently engaged. The software will disable all the front panel switches and set the unit to its previous setting so that the unit may still be used to complete an operation. Power the system OFF and then ON again. The camera will start its internal self-test and will take approximately one (1) minute to finish. If the **L. S. Panel Switch Fail** message is displayed again, return to Linatec for service.

Index

A

Accessories, 3, 4, 8, 9, 15-17, 61
Application, 5
Auto, 6, 7, 9, 24, 26, 27, 33, 35, 36, 38, 43-45
Auto shutter, 26

B

BNC, 2, 7, 8, 15, 36, 62, 64
Brightness, 6, 9, 17, 23-26, 31, 43-45
 decrease, 6, 10, 17, 23-26, 35, 36, 38, 43, 44
 increase, 6, 10, 17, 23, 25, 26, 31, 35-38, 43, 44
 indicator, 6, 43
 LED, 6, 25, 38
 operation, 44
Button, 6, 10, 17, 18, 23, 24, 26, 31-33, 43, 44
 auto, 6, 9, 33, 43
 leakage, 18
 manual, 6, 10, 17, 24, 32, 43, 44

C

Cable, 2, 3, 8, 13, 15, 16, 26, 36, 72
 BNC, 2, 8, 15, 36, 62
 camera, 3
 power, 2-4, 7, 8, 13, 15, 18, 22, 28, 29, 41, 63
 video communication, 3, 8, 15, 72
Calibration, 12, 13, 21, 25-27, 40, 41
Camera, 1, 3, 7-10, 15-17, 21, 25-27, 32, 33, 37-40,
 45, 72, 73
Care and handling of CMOS logic, 61
Chassis parts, 64
Claim, 2
Cleaning, 4
COMM/Bit board, 1, 7, 23, 25, 26, 42, 43, 45, 46, 69
Communications, 7, 45, 47, 72
Components, 2
 comm/bit board, 69, 70
 display board, 66
 motor control board, 67, 68
 mother/power supply board, 65
Controls and indicators
 front panel, 6
 rear panel, 7

D

Decrease, 6, 10, 17, 23-26, 35, 36, 38, 43, 44, 45
Description
 instrument, 1
 manual, 1
Display board, 34, 35, 38, 40, 42-44

E

Error messages, 9, 16, 32, 33, 36, 38, 40, 73

F

Functional test, 15
Fuse, 5, 7, 20, 28, 29, 39, 42, 64
 replacement, 20

G

Ground bond test, 18

I

Increase, 6, 10, 17, 23, 25, 26, 31, 35, 43, 44
Incoming/periodic inspection, 12
Indicator, 6, 8, 15, 18, 30, 32, 43
Installation, 8
Introduction, 12
Iso-potential, 5, 7, 64

J

Jumper board, 23, 24, 26, 42, 45

L

Lamp
 care, 18
 inspection, 13
 interlock, 29, 30, 42
 module, 2, 9, 10, 13, 14, 17, 19, 20, 22, 29, 30,
 32, 40, 42, 43, 72
 replacement, 10, 19
Lamp test, 8, 9, 15, 17, 18, 30, 32, 43
 indicator, 6, 8, 15, 18, 30, 32, 43
Leakage, 5, 13, 18, 24, 28, 61
Leakage test, 13, 18
LED, 6, 8, 15, 25, 26, 34, 35, 38, 40, 43, 44, 66, 69
Light guide, 3, 6, 8, 15, 16, 21, 22, 25, 31, 32
Line filter, 28, 42

Index

LIS8430 Xenon
Light Source

M

- Mechanical inspection, 13
- Mode, 6, 9, 10, 23-27, 32, 33, 35, 36, 38, 44, 44, 61
 - auto, 6, 9, 24, 26, 27, 33, 36, 38, 44, 45
 - manual, 6, 10, 24-27, 33, 35, 45
- Mother/Power Supply board, 22, 23, 32, 33, 40, 42, 43, 63, 65
- Motor Control board, 35-37, 39, 42-44

O

- Options and features, 1
- Operating instructions, 9

P

- Precautions, 3
- Power supplies, 42

R

- Receiving inspection, 2
- Recommended spare parts, 62, 63
- Reliability and performance, 12
- Replacement parts, 61

S

- Safety check-out, 41
- Shutter, 21, 22, 24, 26, 27, 35, 39, 43-45, 73
- Status indicators, 46
- Symbol Definitions, 5

T

- Test
 - ground bond, 18
 - leakage, 18
- Technical specifications, 71
- Troubleshooting, 28-40

V

- Video communication cable assembly, 3, 8, 15, 72



Linvatec

**Linvatec Corporation
11311 Concept Boulevard
Largo, Florida 34643 USA**

International Department

**800-237-0169
813-399-5256 FAX**

**813-392-6464
813-397-4540 FAX - INT'L**